

AMERICAN PEERLESS  
*Wall Radiators*

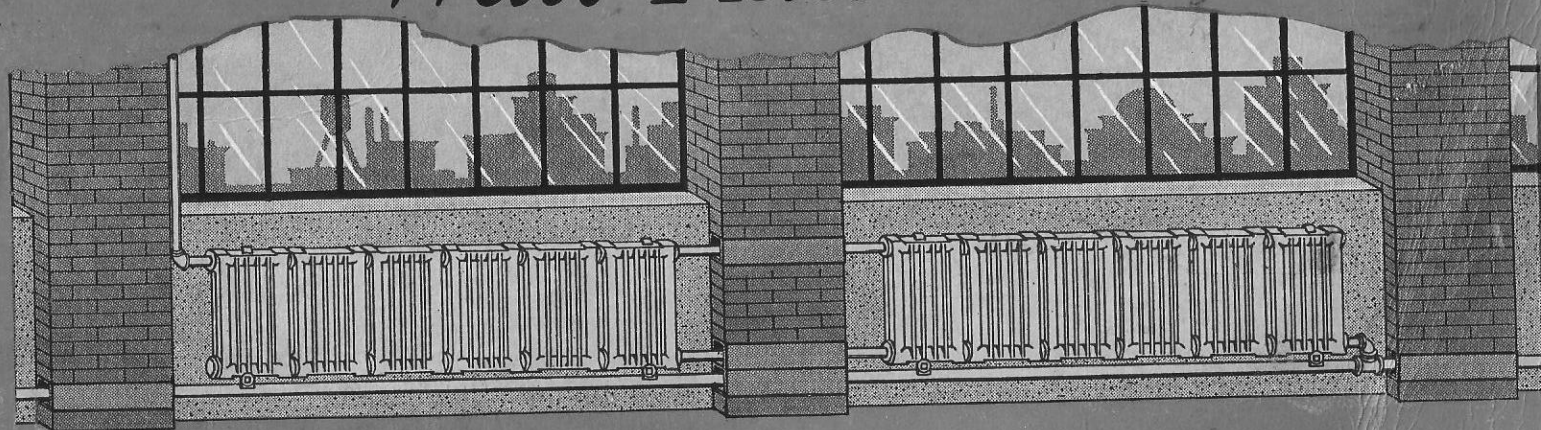

# *American Peerless Wall Radiators*

*In connection with*

Arco Adjustable Brackets, Arco Adjustable Trapeze Supports, Arco Slip End Supports, Arco Safety Concrete Inserts, Arco Attachable Legs, Arco Pendant Flights, Arco Clearway Forms, Arco Backset Connections and Arco Greenhouse Radiator Post Supports

*Information and data for Engineers, Architects, Contractors and Owners relating to Efficient, Economical and Durable Heating, Humidifying, Drying and Cooling Installations for many kinds and classes of structures*

---

---

Your calls are cordially invited

---

AMERICAN PEERLESS  
WALL RADIATORS

# AMERICAN RADIATOR COMPANY

General Executive Office: 40 W. 40th St., New York

Western Executive Office: 816 S. Michigan Ave., Chicago

General Sales Department: 1807 Elmwood Ave., Buffalo

NEW YORK.....	40 West 40th St.	RICHMOND.....	421 N. Seventeenth St.	INDIANAPOLIS.....	401 Pennway Bldg.
NEW YORK (BAYONNE) ..	Foot of E. 46th St.	BUFFALO.....	220 Delaware Ave.	ST. LOUIS.....	4201 Duncan Ave.
BOSTON.....	129-131 Federal St.	PITTSBURGH.....	337-339 Second Ave.	ST. PAUL....	Prior and Minnehaha Aves.
PROVIDENCE..	408-410 Hospital Trust Bldg.	CLEVELAND.....	509 Hanna Bldg.	OMAHA.....	413-417 S. Tenth St.
PORTLAND (ME.)..	416-418 Commercial St.	DETROIT....	Fourth Floor Barlum Bldg.	KANSAS CITY .....	906 Davidson Bldg.
NEW HAVEN.....	S. Front and River Sts.	CINCINNATI.....	710 Gwynne Bldg.	DENVER.....	24th and Blake Sts.
NEWARK.....	402 Broad St.	ATLANTA.....	232 Peachtree St.	SAN FRANCISCO ..	2nd and Townsend Sts.
PHILADELPHIA.....	25th and Reed Sts.	BIRMINGHAM.....	North Birmingham	LOS ANGELES..	601 Com'l Exchange Bldg.
BALTIMORE.....	1308 Lexington Bldg.	CHICAGO.....	816-820 S. Michigan Ave.	SEATTLE.....	Holgate and Utah Sts.
WASHINGTON.....	1308 H St., N. W.	MILWAUKEE.....	1801 St. Paul Ave.		

*Copyrighted 1925 by*

AMERICAN RADIATOR COMPANY

NOTE: *It is intended that the entire contents of this volume (title, text, illustrations and tables) shall be fully protected by this copyright.*

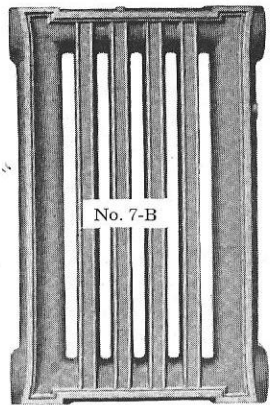

No. 7-B

7-B Section

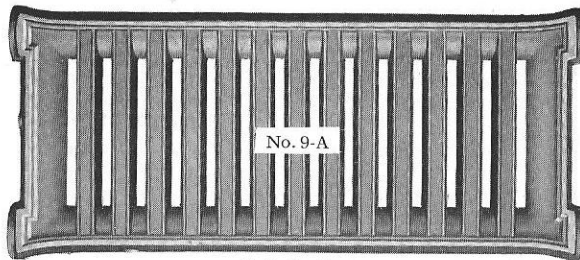

No. 9-A

9-A Section

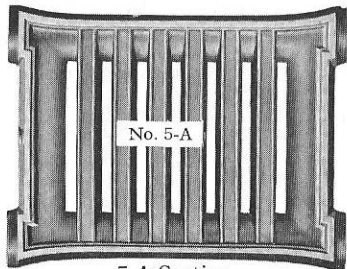

No. 5-A

5-A Section

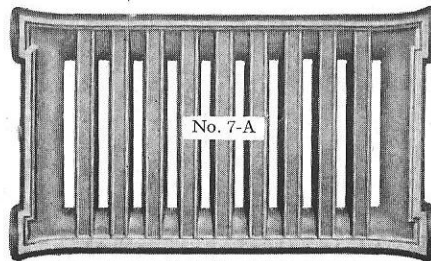

No. 7-A

7-A Section

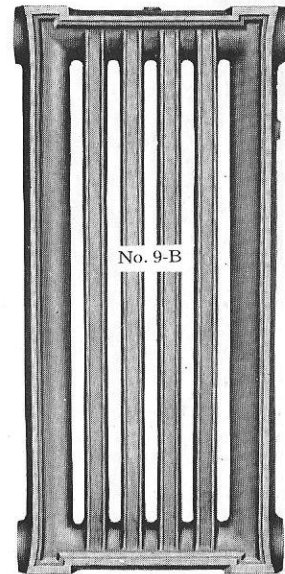

No. 9-B

9-B Section

AMERICAN Peerless Wall Radiators are made in five sizes, as illustrated. For measurements, heating surfaces and tappings, see pages 14 to 18. Should always be assembled with bars vertical to insure highest heating efficiency.

THE AMERICAN Peerless Wall Radiator is the foremost improvement in the heating field, for it replaces the troublesome pipe coil and other antiquated types of heating surface. As the pipe radiator of years ago was replaced by the cast-iron form, so the coil has been supplanted by the AMERICAN Peerless Wall Radiator.

The AMERICAN Peerless Wall Radiator was developed to supply a demand for efficiency, and it has been successful. A study of the design will show elimination of friction-giving passages, which feature allows operation with less power, pressure or vacuum, as the case may be, and eliminates many air-venting problems.

The mechanic approves of this type of radiation, since he can always make a proper circulating as well as a good-

looking job. The owners will like it because it looks better, fits in better, is more efficient, and occupies less space.

The AMERICAN Peerless Wall Radiator does not wear out. The story of replacing heating surface after a number of years is now obsolete, for AMERICAN Peerless Wall Radiators are a part of the building as much as the ground upon which it is built. Being made of cast iron, it can stand the roughest use in any type of heating plant. The sections are connected together by means of heavy right- and left-hand nipples of malleable iron, and the connecting openings are made with cast-iron bushings. Nipples are several times the weight of standard pipe (this at the thread line). Being made of malleableized iron, these nipples exhibit the same remarkable resisting qualities to the action of steam and water as does the radiator surface.

We gladly supply, on request, a series of laboratory test sheets showing, under 2 pounds steam pressure at boiler, an average coefficient of 2.121 per square foot of AMERICAN Peerless Wall Radiators.

The water content of these Radiators is about fifteen-hundredths of a gallon per square foot.

All regular AMERICAN Peerless Wall Radiators are tested at factory to 100 to 120 pounds pressure. Radiators for higher working pressure than 40 pounds can be made on special order. Sections weigh about 7 pounds per square foot.

Many combinations of groupings can be made and, with a little thought, very successful applications are possible.

AMERICAN Peerless Wall Radiators never lose their value. If a building is remodeled, extended or otherwise altered,

they can always be used again without loss—100 per cent salvage!

Ingenious methods of supporting AMERICAN Peerless Wall Radiators are shown—on walls, on ceilings, on girders and in almost any part of the building. As illustrated, the installation is simple—the ARCO Brackets, Supports, Hangers, Pendant Flights, Post Supports or Inserts being set and the Radiator placed on them and adjusted for pitch. These splendid devices, together with the Clearway Forms and Backset Connections, constitute an unequalled line of accessories, which will do much to advance and popularize heating.

The following pages contain descriptive matter, showing methods of application, measurements, surface, installations, telegraph code, etc.

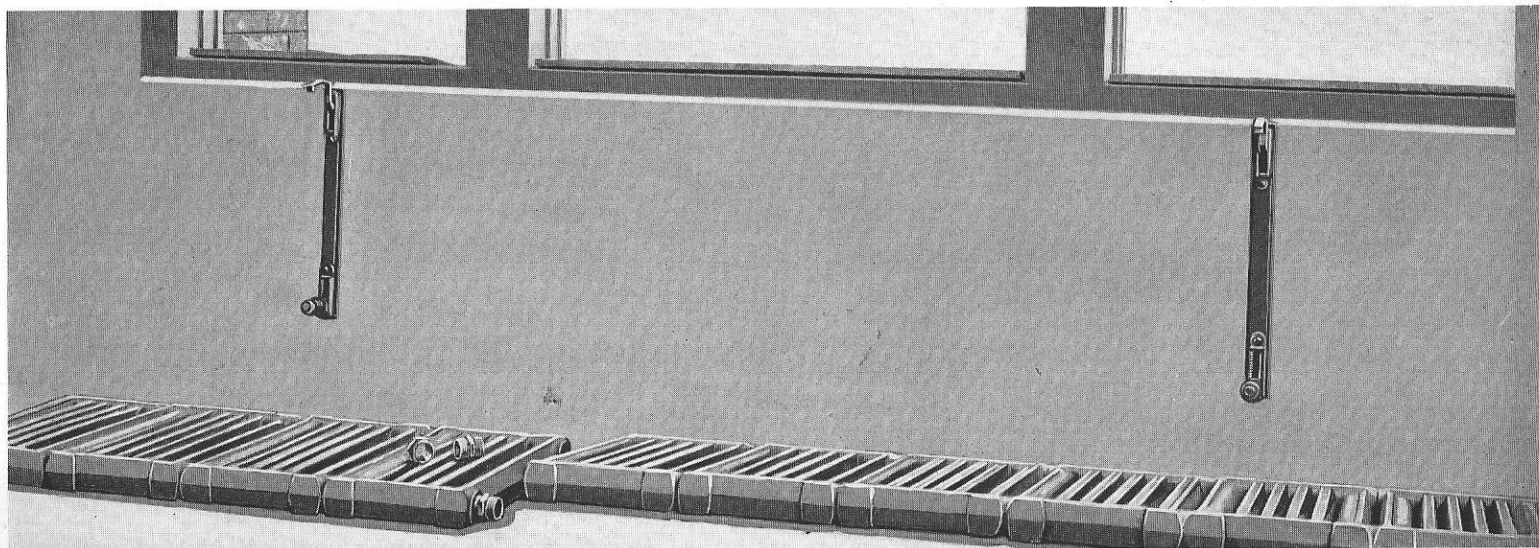

Fig. 100. ARCO Adjustable Wall Brackets in position. Right- and left-hand hexagon nipples ready for use in connecting up two shipping stacks of AMERICAN Peerless Wall sections to make one radiator.

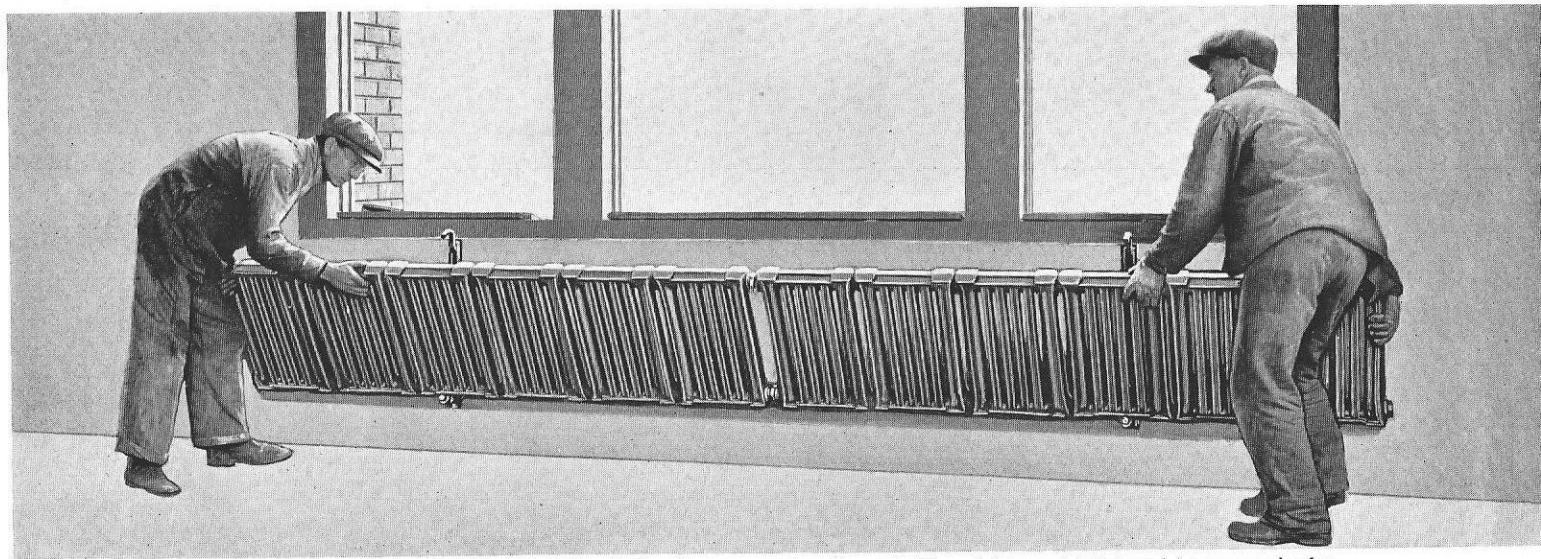

Fig. 101. AMERICAN Peerless Wall Radiation in two stacks, connected by right- and left-hand hexagon nipples, being lifted into position on lower spools of two ARCO Adjustable Wall Brackets.



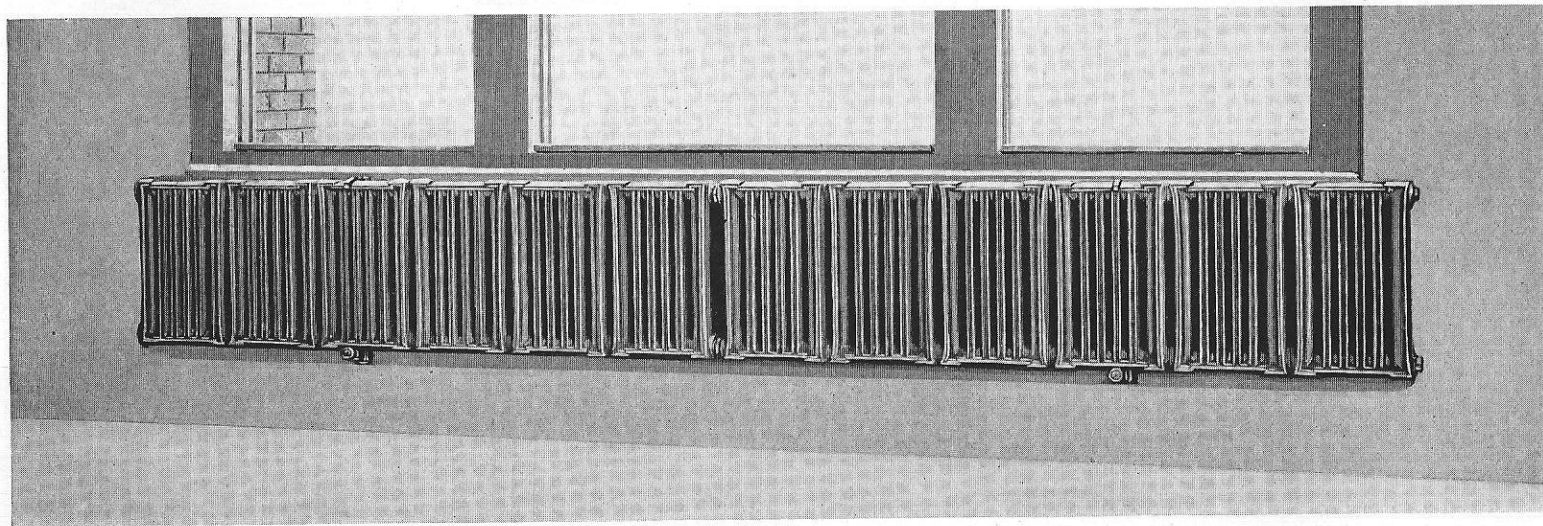

Fig. 102. After three operations, AMERICAN Peerless Wall Radiation shown in position, ready for piping connections—or ready in after years to be changed at owner's will in size, in position, etc.

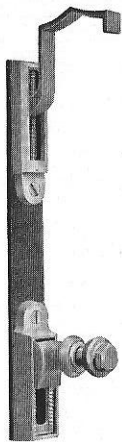

Fig. 103. ARCO Adjustable Wall Bracket, Single Spool, for single row of radiation.

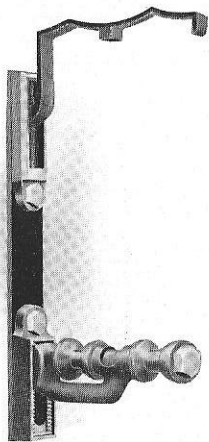

Fig. 104. ARCO Adjustable Wall Bracket, Double Spool, for double row of radiation.

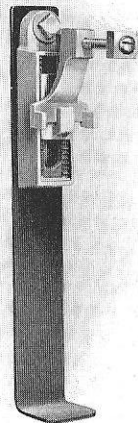

Fig. 105. ARCO Junior Wall Bracket, for single row of radiation.

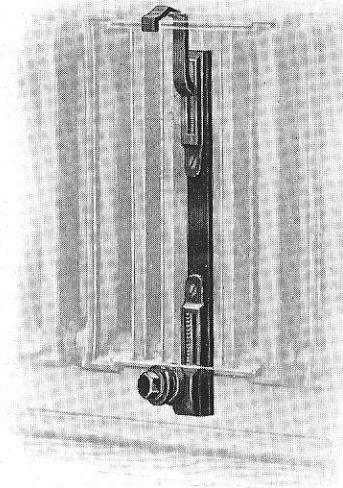

Fig. 106. Shadow view showing how AMERICAN Peerless Wall Radiators are held by the ARCO Adjustable Bracket, Single Spool.

**A**RCO Adjustable Wall Brackets have many unusual features and fulfill the demands of the most difficult installations. They are strong, easy to erect, adjustable, and they make a neat and attractive job.

Expansion and contraction are provided for, no matter how long the run of Wall Radiators may be. The spools on the bottom Bracket allow a free horizontal movement of the Radiators, thus taking care of any difference in "roughing in" measurements, and affording free play for expansion and contraction. Unsightly, sagging, air-bound runs of pipe coil need no longer be tolerated.

The V-shaped spool makes it impossible for the Radiator to jump from the Bracket. The finger of the top Bracket guides the Radiator and keeps it from tipping forward.

By the use of these Brackets, which permit a vertical

adjustment of 2 inches, the fitter can adjust for "pitch" after they have been attached to the wall. The Single-Spool Brackets set the outer face of the Radiator  $4\frac{3}{4}$  inches from the wall. Retaining bolt is  $\frac{1}{2}$  inch diameter.

Bearing plates and bolts of ARCO and ARCO Junior Adjustable Wall Bracket are of wrought iron. The remainder of the Bracket is made of malleable iron.

#### Arco Junior Wall Bracket

The ARCO Junior Wall Bracket is made for smaller units of radiation; it requires only one bolt for fastening, as shown; has an upright alignment of  $1\frac{1}{2}$  inches and a horizontal slip of 1 inch.

This type of Bracket can be economically used on all sizes of AMERICAN Peerless Wall Radiators where extreme expansion is not to be considered.

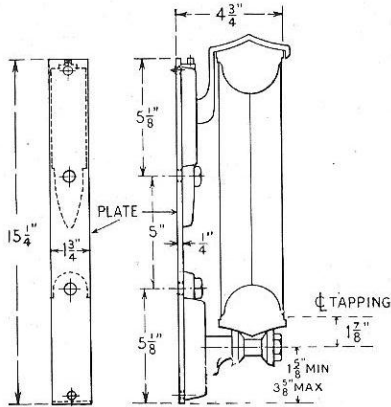

Fig. 107. ARCO Adjustable Wall Bracket, No. 1 Single. For all "A" Sections of AMERICAN Peerless Wall Radiators.

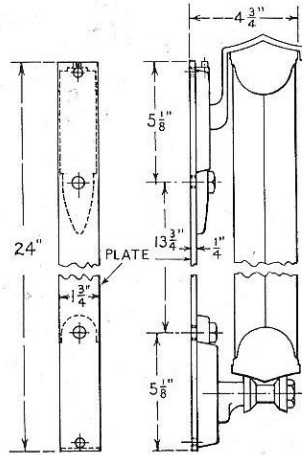

Fig. 108. ARCO Adjustable Wall Bracket, No. 2 Single. For 7-B Sections of AMERICAN Peerless Wall Radiators.

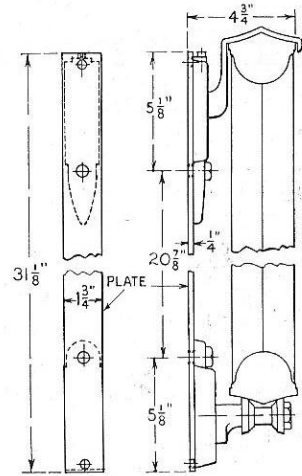

Fig. 109. ARCO Adjustable Wall Bracket, No. 3 Single. For 9-B Sections of AMERICAN Peerless Wall Radiators.

See also pages 9, 10 and 22.

Arco Adjustable Wall Brackets, Double-Spool—Showing Application

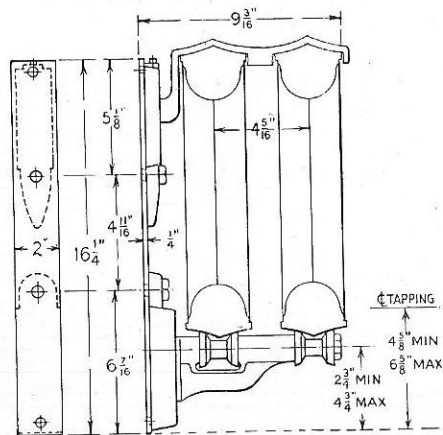

Fig. 110. ARCO Adjustable Wall Bracket, No. 1 Double. For all "A" Sections of AMERICAN Peerless Wall Radiators.

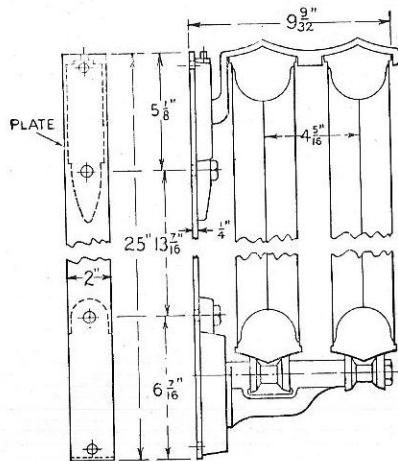

Fig. 111. ARCO Adjustable Wall Bracket, No. 2 Double. For 7-B Sections of AMERICAN Peerless Wall Radiators.

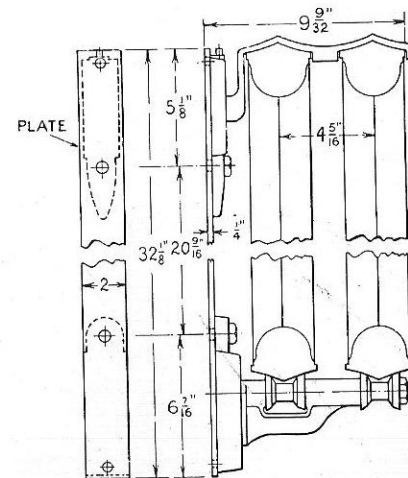
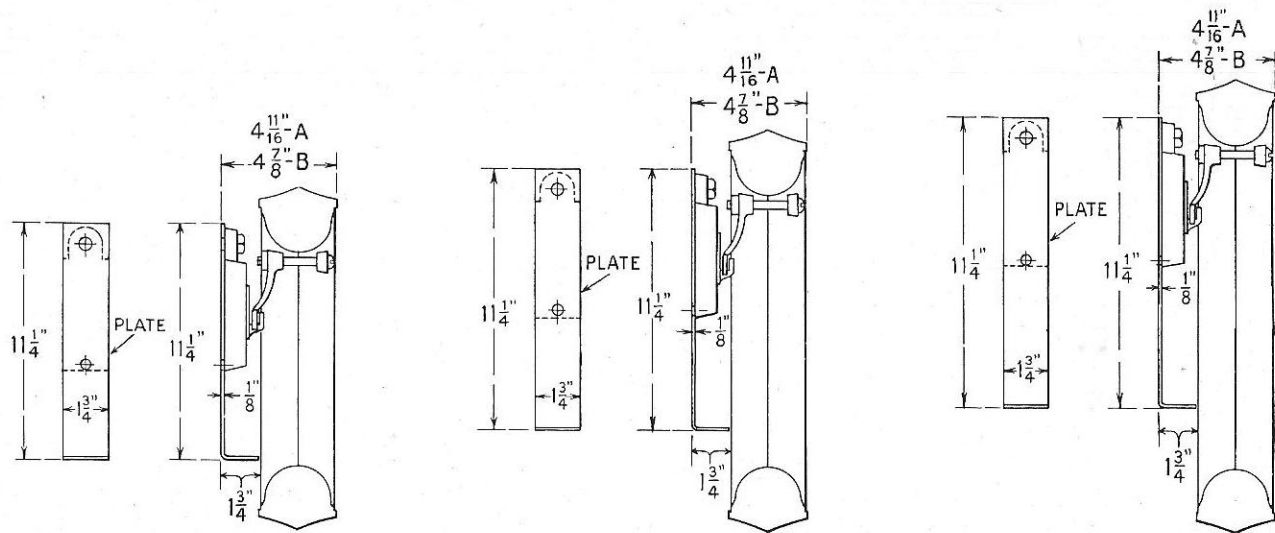

Fig. 112. ARCO Adjustable Wall Bracket, No. 3 Double. For 9-B Sections of AMERICAN Peerless Wall Radiators.

See also pages 9, 10 and 22.



Figs. 113, 114 and 115. Show ARCO Junior Adjustable Wall Bracket No. 1 (made only in one size) applied to 5-, 7- and 9-square-foot Sections, respectively. See also pages 9, 10 and 23.

# Type 5-A—5 Square Feet per Section

AMERICAN PEERLESS  
WALL RADIATORS

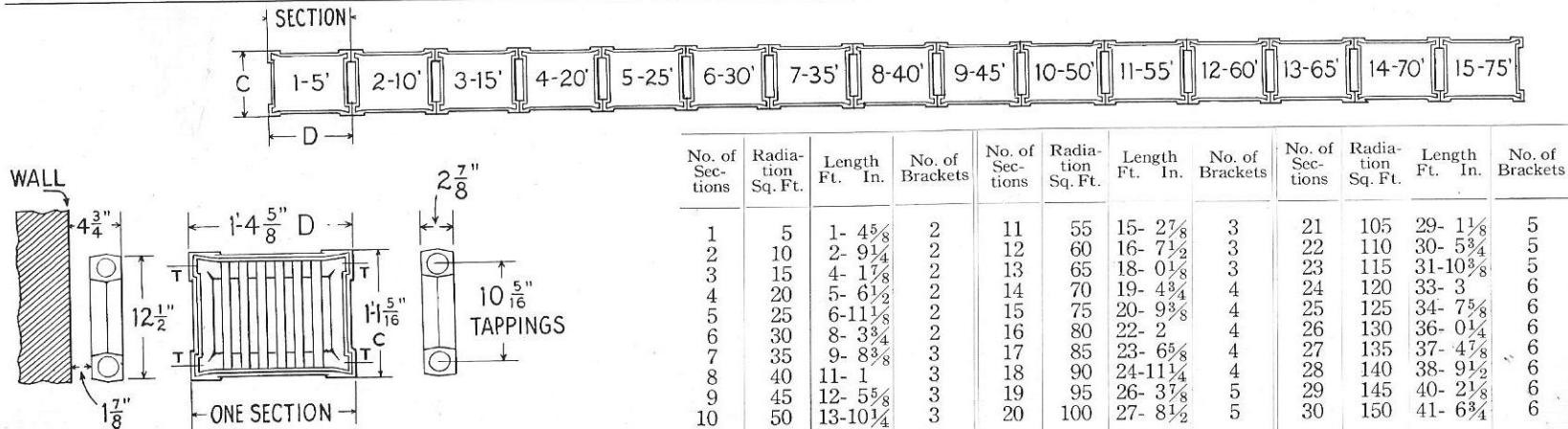

Fig. 116

No. of Sections	Radiation Sq. Ft.	Length Ft. In.	No. of Brackets	No. of Sections	Radiation Sq. Ft.	Length Ft. In.	No. of Brackets	No. of Sections	Radiation Sq. Ft.	Length Ft. In.	No. of Brackets
1	5	1- 4 <sup>5</sup> / <sub>8</sub>	2	11	55	15- 2 <sup>7</sup> / <sub>8</sub>	3	21	105	29- 1 <sup>1</sup> / <sub>8</sub>	5
2	10	2- 9 <sup>1</sup> / <sub>4</sub>	2	12	60	16- 7 <sup>1</sup> / <sub>2</sub>	3	22	110	30- 5 <sup>3</sup> / <sub>4</sub>	5
3	15	4- 1 <sup>7</sup> / <sub>8</sub>	2	13	65	18- 0 <sup>1</sup> / <sub>8</sub>	3	23	115	31- 10 <sup>3</sup> / <sub>8</sub>	5
4	20	5- 6 <sup>1</sup> / <sub>2</sub>	2	14	70	19- 4 <sup>3</sup> / <sub>4</sub>	4	24	120	33- 3	6
5	25	6- 11 <sup>1</sup> / <sub>8</sub>	2	15	75	20- 9 <sup>3</sup> / <sub>8</sub>	4	25	125	34- 7 <sup>5</sup> / <sub>8</sub>	6
6	30	8- 3 <sup>3</sup> / <sub>4</sub>	2	16	80	22- 2	4	26	130	36- 0 <sup>1</sup> / <sub>4</sub>	6
7	35	9- 8 <sup>3</sup> / <sub>8</sub>	3	17	85	23- 6 <sup>5</sup> / <sub>8</sub>	4	27	135	37- 4 <sup>7</sup> / <sub>8</sub>	6
8	40	11- 1	3	18	90	24- 11 <sup>1</sup> / <sub>4</sub>	4	28	140	38- 9 <sup>1</sup> / <sub>2</sub>	6
9	45	12- 5 <sup>5</sup> / <sub>8</sub>	3	19	95	26- 3 <sup>7</sup> / <sub>8</sub>	5	29	145	40- 2 <sup>1</sup> / <sub>8</sub>	6
10	50	13- 10 <sup>1</sup> / <sub>4</sub>	3	20	100	27- 8 <sup>1</sup> / <sub>2</sub>	5	30	150	41- 6 <sup>3</sup> / <sub>4</sub>	6

For supports, see page 9.

For "Directions for Ordering," see page 53.

Sections are tapped for 1½-inch pipe.

If bushings are used, add ½ inch for each.

Unless otherwise ordered, Type 5-A Radiators are shipped in stacks of not more than six sections.

Larger Radiators are joined by malleable-iron hexagon, right- and left-hand threaded nipples for each addition of six or less sections.

For each hexagon nipple used add 1⅛ inches to the lengths given in the table. See scale for laying out on drawings, pages 22 and 23.

Radiators of greater lengths can be figured from the table.

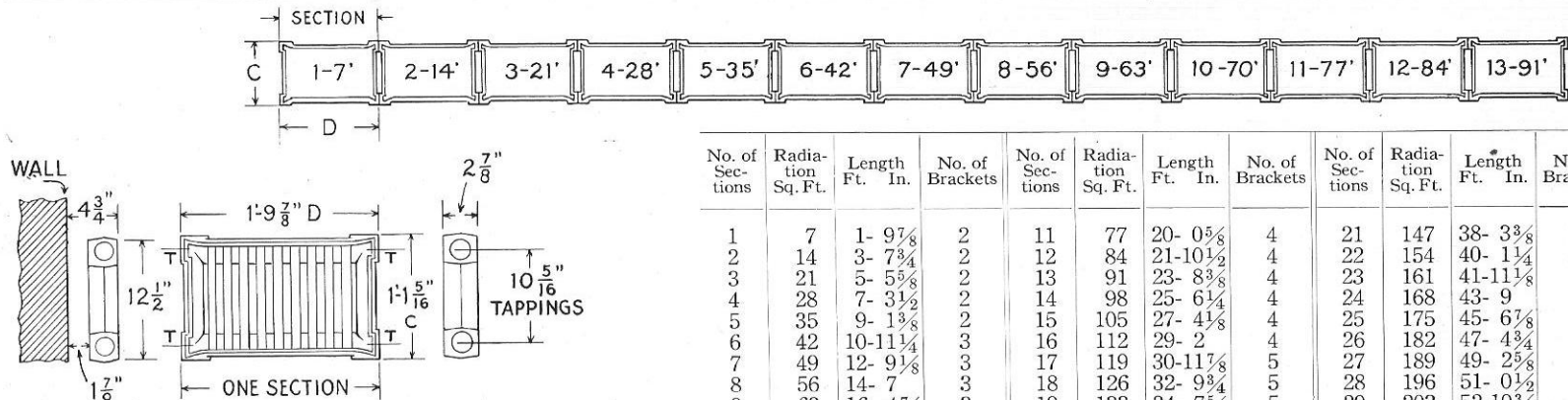

Fig. 117

No. of Sections	Radiation Sq. Ft.	Length Ft. In.	No. of Brackets	No. of Sections	Radiation Sq. Ft.	Length Ft. In.	No. of Brackets	No. of Sections	Radiation Sq. Ft.	Length Ft. In.	No. of Brackets
1	7	1- 9 7/8	2	11	77	20- 0 5/8	4	21	147	38- 3 3/8	5
2	14	3- 7 3/4	2	12	84	21-10 1/2	4	22	154	40- 1 1/4	5
3	21	5- 5 5/8	2	13	91	23- 8 3/8	4	23	161	41-11 1/8	5
4	28	7- 3 1/2	2	14	98	25- 6 1/4	4	24	168	43- 9	6
5	35	9- 1 3/8	2	15	105	27- 4 1/8	4	25	175	45- 6 7/8	6
6	42	10-11 1/4	3	16	112	29- 2	4	26	182	47- 4 3/4	6
7	49	12- 9 1/8	3	17	119	30-11 7/8	5	27	189	49- 2 5/8	6
8	56	14- 7	3	18	126	32- 9 3/4	5	28	196	51- 0 1/2	7
9	63	16- 4 7/8	3	19	133	34- 7 5/8	5	29	203	52-10 3/8	7
10	70	18- 2 3/4	3	20	140	36- 5 1/2	5	30	210	54- 8 1/4	7

For supports, see page 9.

For "Directions for Ordering," see page 53.

Sections are tapped for 1 1/2-inch pipe.

If bushings are used, add 1/2 inch for each.

Unless otherwise ordered, Type 7-A Radiators are shipped in stacks of not more than four sections.

Larger Radiators are joined by malleable-iron hexagon, right- and left-hand threaded nipples for each addition of four or less sections.

For each hexagon nipple used add 1 1/8 inches to the lengths given in the table. See scale for laying out on drawings, pages 22 and 23.

Radiators of greater lengths can be figured from the table.



# Type 9-A—9 Square Feet per Section

AMERICAN PEERLESS  
WALL RADIATORS

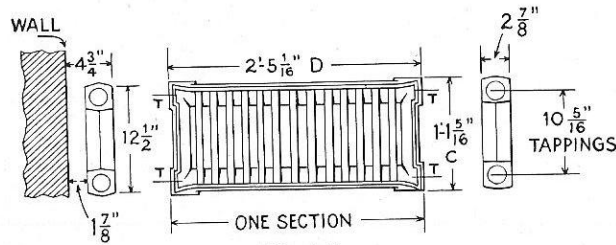
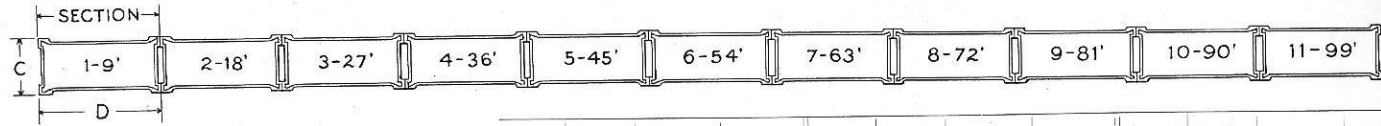

Fig. 118

No. of Sections	Radiation Sq. Ft.	Length Ft. In.	No. of Brackets	No. of Sections	Radiation Sq. Ft.	Length Ft. In.	No. of Brackets	No. of Sections	Radiation Sq. Ft.	Length Ft. In.	No. of Brackets
1	9	2- 5 <sup>1</sup> / <sub>16</sub>	2	11	99	26- 7 <sup>11</sup> / <sub>16</sub>	4	21	189	50-10 <sup>5</sup> / <sub>16</sub>	6
2	18	4-10 <sup>1</sup> / <sub>8</sub>	2	12	108	29- 0 <sup>3</sup> / <sub>4</sub>	4	22	198	53- 3 <sup>3</sup> / <sub>8</sub>	6
3	27	7- 3 <sup>3</sup> / <sub>16</sub>	2	13	117	31- 5 <sup>13</sup> / <sub>16</sub>	5	23	207	55- 8 <sup>7</sup> / <sub>16</sub>	7
4	36	9- 8 <sup>1</sup> / <sub>4</sub>	2	14	126	33-10 <sup>1</sup> / <sub>8</sub>	5	24	216	58- 1 <sup>1</sup> / <sub>2</sub>	7
5	45	12- 1 <sup>5</sup> / <sub>16</sub>	3	15	135	36- 3 <sup>15</sup> / <sub>16</sub>	5	25	225	60- 6 <sup>9</sup> / <sub>16</sub>	7
6	54	14- 6 <sup>3</sup> / <sub>8</sub>	3	16	144	38- 9	5	26	234	62-11 <sup>5</sup> / <sub>8</sub>	7
7	63	16-11 <sup>7</sup> / <sub>16</sub>	3	17	153	41- 2 <sup>1</sup> / <sub>16</sub>	5	27	243	65- 4 <sup>11</sup> / <sub>16</sub>	8
8	72	19- 4 <sup>1</sup> / <sub>2</sub>	3	18	162	43- 7 <sup>1</sup> / <sub>8</sub>	6	28	252	67- 9 <sup>3</sup> / <sub>4</sub>	8
9	81	21- 9 <sup>9</sup> / <sub>16</sub>	4	19	171	46- 0 <sup>3</sup> / <sub>16</sub>	6	29	261	70- 2 <sup>13</sup> / <sub>16</sub>	8
10	90	24- 2 <sup>5</sup> / <sub>8</sub>	4	20	180	48- 5 <sup>1</sup> / <sub>4</sub>	6	30	270	72- 7 <sup>1</sup> / <sub>8</sub>	8

For supports, see page 9.

For "Directions for Ordering," see page 53.

Sections are tapped for 1 1/2-inch pipe.

If bushings are used, add 1/2 inch for each.

Unless otherwise ordered, Type 9-A Radiators are shipped in stacks of not more than three sections.

Larger Radiators are joined by malleable-iron hexagon, right- and left-hand threaded nipples for each addition of three or less sections.

For each hexagon nipple used add 1 1/8 inches to the lengths given in the table. See scale for laying out on drawings, pages 22 and 23.

Radiators of greater lengths can be figured from the table.

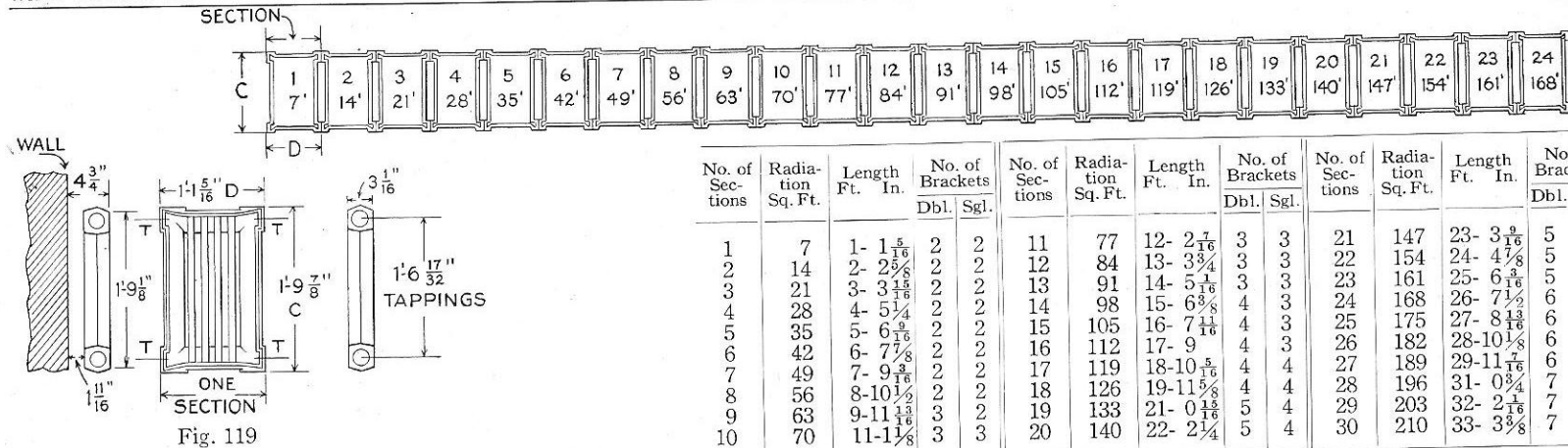

Fig. 119

For supports, see page 9.

For "Directions for Ordering," see page 53.

Sections are tapped for 1 $\frac{1}{2}$ -inch pipe.

If bushings are used, add  $\frac{1}{2}$  inch for each.

Unless otherwise ordered, Type 7-B Radiators are shipped in stacks of not more than seven sections.

Larger Radiators are joined by malleable-iron hexagon, right- and left-hand threaded nipples for each addition of seven or less sections.

For each hexagon nipple used add 1 $\frac{1}{8}$  inches to the lengths given in the table. See scale for laying out on drawings, pages 22 and 23.

Radiators of greater lengths can be figured from the table.

# Type 9-B—9 Square Feet per Section

AMERICAN PEERLESS  
WALL RADIATORS

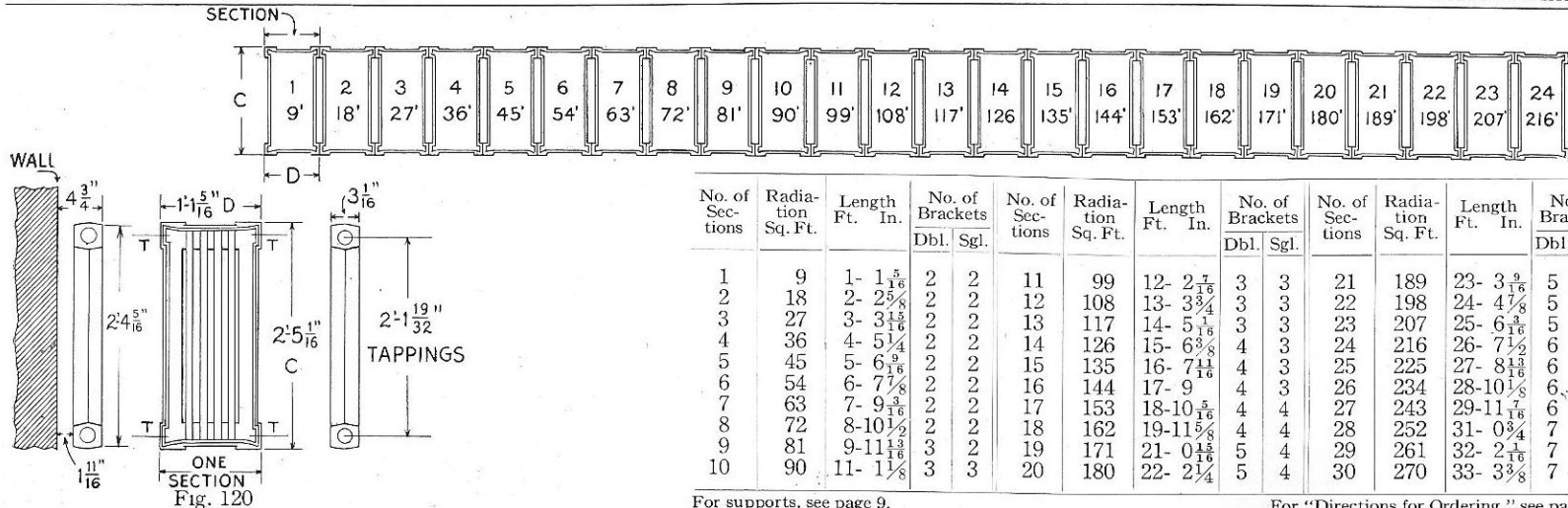

No. of Sections	Radiation Sq. Ft.	Length Ft. In.	No. of Brackets		No. of Sections	Radiation Sq. Ft.	Length Ft. In.	No. of Brackets		No. of Sections	Radiation Sq. Ft.	Length Ft. In.	No. of Brackets	
			Dbl.	Sgl.				Dbl.	Sgl.				Dbl.	Sgl.
1	9	1- $1\frac{5}{16}$	2	2	11	99	12- $2\frac{7}{16}$	3	3	21	189	23- $3\frac{9}{16}$	5	4
2	18	2- $2\frac{5}{8}$	2	2	12	108	13- $3\frac{3}{4}$	3	3	22	198	24- $4\frac{7}{8}$	5	4
3	27	3- $3\frac{15}{16}$	2	2	13	117	14- $5\frac{1}{16}$	3	3	23	207	25- $6\frac{3}{16}$	5	5
4	36	4- $5\frac{1}{4}$	2	2	14	126	15- $6\frac{3}{8}$	4	3	24	216	26- $7\frac{1}{2}$	6	5
5	45	5- $6\frac{9}{16}$	2	2	15	135	16- $7\frac{11}{16}$	4	3	25	225	27- $8\frac{13}{16}$	6	5
6	54	6- $7\frac{7}{8}$	2	2	16	144	17- $9$	4	3	26	234	28- $10\frac{1}{8}$	6	5
7	63	7- $9\frac{3}{16}$	2	2	17	153	18- $10\frac{5}{16}$	4	4	27	243	29- $11\frac{7}{16}$	6	5
8	72	8- $10\frac{1}{2}$	2	2	18	162	19- $11\frac{5}{8}$	4	4	28	252	31- $0\frac{3}{4}$	7	5
9	81	9- $11\frac{13}{16}$	3	2	19	171	21- $0\frac{15}{16}$	5	4	29	261	32- $2\frac{1}{16}$	7	6
10	90	11- $1\frac{1}{8}$	3	3	20	180	22- $2\frac{1}{4}$	5	4	30	270	33- $3\frac{3}{8}$	7	6

For supports, see page 9.

For "Directions for Ordering," see page 53.

Sections are tapped for  $1\frac{1}{2}$ -inch pipe.

If bushings are used, add  $\frac{1}{2}$  inch for each.

Unless otherwise ordered, Type 9-B Radiators are shipped in stacks of not more than seven sections.

Larger Radiators are joined by malleable-iron hexagon, right- and left-hand threaded nipples for each addition of seven or less sections.

For each hexagon nipple used add  $1\frac{1}{8}$  inches to the lengths given in the table.

See scale for laying out on drawings, pages 22 and 23.

Radiators of greater lengths can be figured from the table.

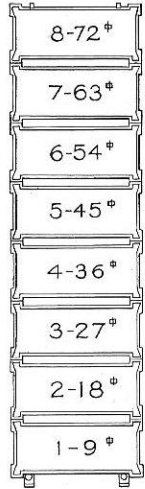

9-A  
Fig. 121



7-A  
Fig. 122



5-A  
Fig. 123



END VIEW  
Fig. 124

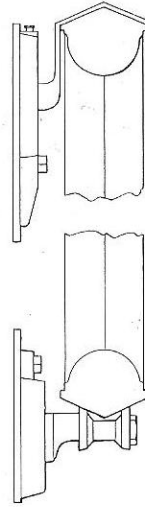

ENLARGED VIEW OF HANGERS  
Fig. 125

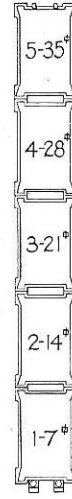

7-B  
Fig. 126

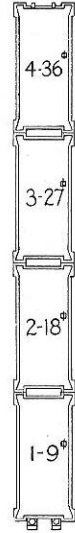

9-B  
Fig. 127

Suggested forms of application to piers or narrow spacings. It will be seen in these applications that the bars of the radiator sections are always vertical.

THE increasing use of AMERICAN Peerless Wall Radiators, hung on ARCO Adjustable Wall Brackets to walls and partitions, prompts us to suggest the following simple and practical methods of installation, which insure good jobs.

For attaching ARCO Adjustable Brackets to stone, cement or brick walls the proper use of the expansion bolt always gives the best results. Ordinary nails and screws frequently work loose, pull out or break and cannot be depended upon for secure and permanent work.

Progressive fitters have found that the following method saves time and gives best results:

To start the hole in the wall, use a "rose drill." After carefully locating the hole centers, start the hole with light

blows of the hammer, being careful not to allow the drill to jump about. Thus a smooth bore is started without cracking the surface of the wall adjacent to the hole. After hole has been drilled about  $\frac{1}{4}$  inch use more force, being careful to turn the drill slightly between blows, as this prevents the cutting edges striking the same point twice and produces more rapid work. (Fig. 128.) Drill hole slightly deeper than the length of the shield to be inserted so that the lag screw will

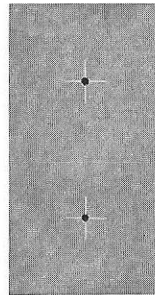

Fig. 128. Locating and Drilling Hole Centers

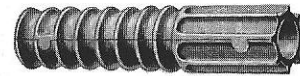

Fig. 129-A. Expansion Bolt Shield



Fig. 129-B. Lag Screw in Expansion Bolt Shield

project beyond the inner end and enable turning the work up tight to the wall when the screw is turned in.

Where few holes are to be drilled a hand hammer with a rose drill will give good results, but for larger work requiring numerous holes a great saving in time may be made by using a "Rapid Fire" drill. This drill works similarly to a pneumatic hammer.

After the hole is drilled accurately the shield can be inserted by hand or lightly driven in by hammer. (Fig. 129.) Drive beyond the face of the wall. Then place the plate or bracket to be attached, over the shield; then insert lag screw by hand as far as can be turned and continue turning with hand wrench or socket wrench in a brace until it has tightly drawn the work up against the wall. (Fig. 130.)

If lag screw binds at any point due to grit from wall, give it a reverse turn and then continue.

By use of the expansion bolt as previously described, ARCO Adjustable Brackets are held tightly and permanently against the wall in the simplest manner, making the installation enduring

and "ship shape."

Illustrations on pages 6 to 8 and 45 to 48 suggest some of the ways in which Radiators and Brackets may be employed.

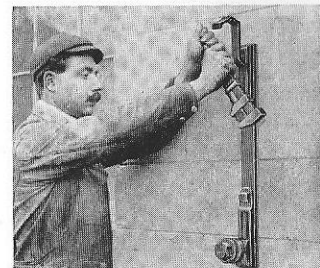

Fig. 130. Turning Up Lag Screw

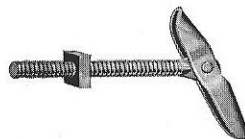

Fig. 131. Wing Bolt for Hollow Tile Walls

**S**HOWS number and location of ARCO Adjustable Wall Bracket, Single-Spool, on AMERICAN Peerless Wall Radiators from two to thirty "B" sections long. On runs of thirty to fifty sections, the Brackets should be placed approximately 7 feet or less apart.

Number of Double-Spool Brackets (for two rows of radiation) is given in the tables on pages 17 and 18. With the

Double-Spool ARCO Adjustable Wall Brackets the two runs or stacks of Radiators are separated about  $1\frac{1}{4}$  inches.

Scale to be used for ARCO Junior Adjustable Wall Brackets is shown on page 23.

In calculating lengths of stacks, add  $\frac{1}{2}$  inch for each end bushed, and  $1\frac{1}{8}$  inches for each right- and left-hand hexagon threaded nipple used in assembling.

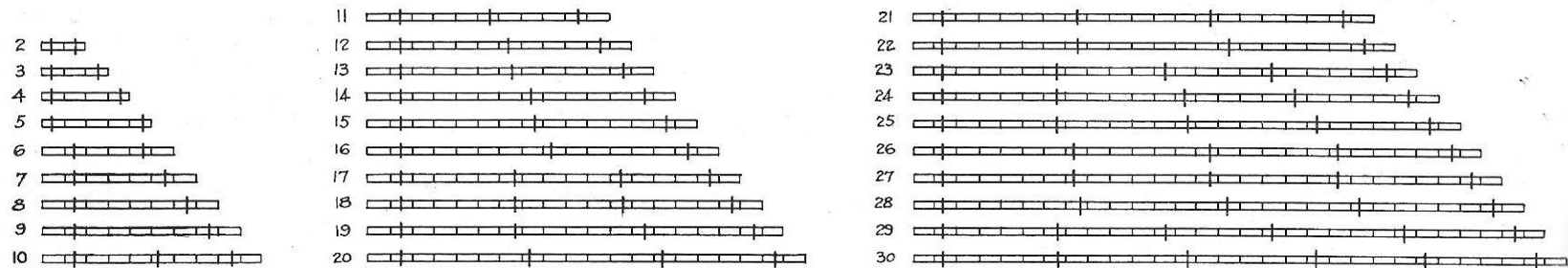

Fig. 132

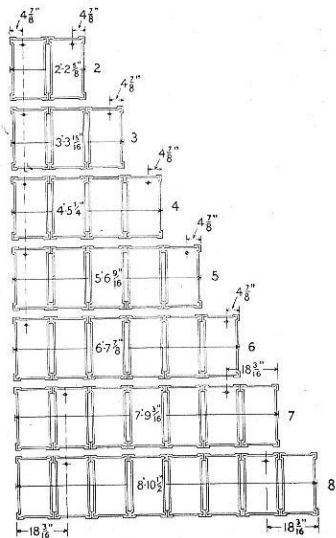

Fig. 133. For 7-B and 9-B  
Assemblages.

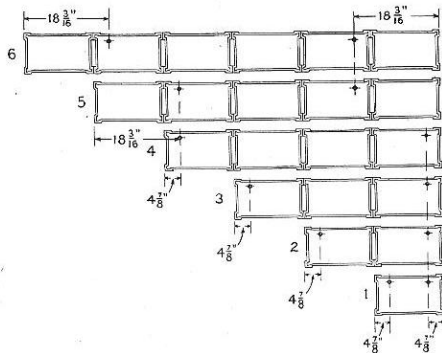

Fig. 134. For all "A" Section Assemblages.

NOTE: Lengths given are face to face of hubs, to which must be added  $1\frac{1}{8}$  inches for each hexagon make-up nipple used.

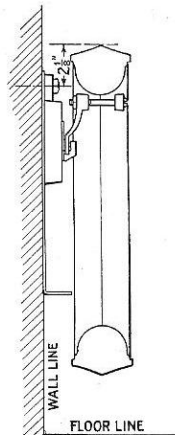

Fig. 135

LENGTH OF "A" ASSEMBLAGES IN FIG. 134

No. of Sections	5 "A" Sections Ft. In.	7 "A" Sections Ft. In.	9 "A" Sections Ft. In.
6	8- 3 $\frac{3}{4}$	10-11 $\frac{1}{4}$	14- 6 $\frac{3}{8}$
5	6-11 $\frac{1}{8}$	9- 13 $\frac{3}{8}$	12- 1 $\frac{5}{16}$
4	5- 6 $\frac{1}{2}$	7- 3 $\frac{1}{2}$	9- 8 $\frac{1}{4}$
3	4- 1 $\frac{7}{8}$	5- 5 $\frac{5}{8}$	7- 3 $\frac{3}{16}$
2	2- 9 $\frac{1}{4}$	3- 7 $\frac{3}{4}$	4-10 $\frac{1}{8}$
1	1- 4 $\frac{5}{8}$	1- 9 $\frac{7}{8}$	2- 5 $\frac{1}{16}$



# Dimensions and Heating Surfaces

AMERICAN PEERLESS  
WALL RADIATORS

No. of Sect.	Length of Space Occupied								Heating Surface, Sq. Ft.			No. of Sect.	Length of Space Occupied								Heating Surface, Sq. Ft.		
	Type 5-A		Type 7-A		Type 9-A		Types 7-B, 9-B		Type 5	Type 7	Type 9		Type 5-A		Type 7-A		Type 9-A		Types 7-B, 9-B		Type 5	Type 7	Type 9
	Ft.	In.	Ft.	In.	Ft.	In.	Ft.	In.				Ft.	In.	Ft.	In.	Ft.	In.	Ft.	In.				
1	1- 4 <sup>5</sup> / <sub>8</sub>		1- 9 <sup>7</sup> / <sub>8</sub>		2- 5 <sup>1</sup> / <sub>16</sub>		1- 1 <sup>5</sup> / <sub>16</sub>		5	7	9	16	22- 2		29- 2		38- 9		17- 9	80	112	144	
2	2- 9 <sup>1</sup> / <sub>4</sub>		3- 7 <sup>3</sup> / <sub>4</sub>		4- 10 <sup>1</sup> / <sub>8</sub>		2- 2 <sup>5</sup> / <sub>8</sub>		10	14	18	17	23- 6 <sup>5</sup> / <sub>8</sub>		30- 11 <sup>7</sup> / <sub>8</sub>		41- 2 <sup>1</sup> / <sub>16</sub>		18- 10 <sup>5</sup> / <sub>16</sub>	85	119	153	
3	4- 1 <sup>7</sup> / <sub>8</sub>		5- 5 <sup>5</sup> / <sub>8</sub>		7- 3 <sup>3</sup> / <sub>16</sub>		3- 3 <sup>15</sup> / <sub>16</sub>		15	21	27	18	24- 11 <sup>1</sup> / <sub>4</sub>		32- 9 <sup>3</sup> / <sub>4</sub>		43- 7 <sup>1</sup> / <sub>8</sub>		19- 11 <sup>5</sup> / <sub>8</sub>	90	126	162	
4	5- 6 <sup>1</sup> / <sub>2</sub>		7- 3 <sup>1</sup> / <sub>2</sub>		9- 8 <sup>1</sup> / <sub>4</sub>		4- 5 <sup>1</sup> / <sub>4</sub>		20	28	36	19	26- 3 <sup>7</sup> / <sub>8</sub>		34- 7 <sup>5</sup> / <sub>8</sub>		46- 0 <sup>3</sup> / <sub>16</sub>		21- 0 <sup>15</sup> / <sub>16</sub>	95	133	171	
5	6- 11 <sup>1</sup> / <sub>8</sub>		9- 1 <sup>3</sup> / <sub>8</sub>		12- 1 <sup>5</sup> / <sub>16</sub>		5- 6 <sup>9</sup> / <sub>16</sub>		25	35	45	20	27- 8 <sup>1</sup> / <sub>2</sub>		36- 5 <sup>1</sup> / <sub>2</sub>		48- 5 <sup>1</sup> / <sub>4</sub>		22- 2 <sup>1</sup> / <sub>4</sub>	100	140	180	
6	8- 3 <sup>3</sup> / <sub>4</sub>		10- 11 <sup>1</sup> / <sub>4</sub>		14- 6 <sup>3</sup> / <sub>8</sub>		6- 7 <sup>7</sup> / <sub>8</sub>		30	42	54	21	29- 1 <sup>1</sup> / <sub>8</sub>		38- 3 <sup>3</sup> / <sub>8</sub>		50- 10 <sup>5</sup> / <sub>16</sub>		23- 3 <sup>9</sup> / <sub>16</sub>	105	147	189	
7	9- 8 <sup>3</sup> / <sub>8</sub>		12- 9 <sup>1</sup> / <sub>8</sub>		16- 11 <sup>7</sup> / <sub>16</sub>		7- 9 <sup>3</sup> / <sub>16</sub>		35	49	63	22	30- 5 <sup>3</sup> / <sub>4</sub>		40- 1 <sup>1</sup> / <sub>4</sub>		53- 3 <sup>3</sup> / <sub>8</sub>		24- 4 <sup>7</sup> / <sub>8</sub>	110	154	198	
8	11- 1		14- 7		19- 4 <sup>1</sup> / <sub>2</sub>		8- 10 <sup>1</sup> / <sub>2</sub>		40	56	72	23	31- 10 <sup>3</sup> / <sub>8</sub>		41- 11 <sup>1</sup> / <sub>8</sub>		55- 8 <sup>7</sup> / <sub>16</sub>		25- 6 <sup>3</sup> / <sub>16</sub>	115	161	207	
9	12- 5 <sup>5</sup> / <sub>8</sub>		16- 4 <sup>7</sup> / <sub>8</sub>		21- 9 <sup>9</sup> / <sub>16</sub>		9- 11 <sup>13</sup> / <sub>16</sub>		45	63	81	24	33- 3		43- 9		58- 1 <sup>1</sup> / <sub>2</sub>		26- 7 <sup>1</sup> / <sub>2</sub>	120	168	216	
10	13- 10 <sup>1</sup> / <sub>4</sub>		18- 2 <sup>3</sup> / <sub>4</sub>		24- 2 <sup>5</sup> / <sub>8</sub>		11- 1 <sup>1</sup> / <sub>8</sub>		50	70	90	25	34- 7 <sup>5</sup> / <sub>8</sub>		45- 6 <sup>7</sup> / <sub>8</sub>		60- 6 <sup>9</sup> / <sub>16</sub>		27- 8 <sup>13</sup> / <sub>16</sub>	125	175	225	
11	15- 2 <sup>7</sup> / <sub>8</sub>		20- 0 <sup>5</sup> / <sub>8</sub>		26- 7 <sup>11</sup> / <sub>16</sub>		12- 2 <sup>7</sup> / <sub>16</sub>		55	77	99	26	36- 0 <sup>1</sup> / <sub>4</sub>		47- 4 <sup>3</sup> / <sub>4</sub>		62- 11 <sup>5</sup> / <sub>8</sub>		28- 10 <sup>1</sup> / <sub>8</sub>	130	182	234	
12	16- 7 <sup>1</sup> / <sub>2</sub>		21- 10 <sup>1</sup> / <sub>2</sub>		29- 0 <sup>3</sup> / <sub>4</sub>		13- 3 <sup>3</sup> / <sub>4</sub>		60	84	108	27	37- 4 <sup>7</sup> / <sub>8</sub>		49- 2 <sup>5</sup> / <sub>8</sub>		65- 4 <sup>11</sup> / <sub>16</sub>		29- 11 <sup>7</sup> / <sub>16</sub>	135	189	243	
13	18- 0 <sup>1</sup> / <sub>8</sub>		23- 8 <sup>3</sup> / <sub>8</sub>		31- 5 <sup>1</sup> / <sub>16</sub>		14- 5 <sup>1</sup> / <sub>16</sub>		65	91	117	28	38- 9 <sup>1</sup> / <sub>2</sub>		51- 0 <sup>1</sup> / <sub>2</sub>		67- 9 <sup>3</sup> / <sub>4</sub>		31- 0 <sup>3</sup> / <sub>4</sub>	140	196	252	
14	19- 4 <sup>3</sup> / <sub>4</sub>		25- 6 <sup>1</sup> / <sub>4</sub>		33- 10 <sup>7</sup> / <sub>8</sub>		15- 6 <sup>3</sup> / <sub>8</sub>		70	98	126	29	40- 2 <sup>1</sup> / <sub>8</sub>		52- 10 <sup>3</sup> / <sub>8</sub>		70- 2 <sup>13</sup> / <sub>16</sub>		32- 2 <sup>1</sup> / <sub>16</sub>	145	203	261	
15	20- 9 <sup>3</sup> / <sub>8</sub>		27- 4 <sup>1</sup> / <sub>8</sub>		36- 3 <sup>15</sup> / <sub>16</sub>		16- 7 <sup>11</sup> / <sub>16</sub>		75	105	135	30	41- 6 <sup>3</sup> / <sub>4</sub>		54- 8 <sup>1</sup> / <sub>4</sub>		72- 7 <sup>7</sup> / <sub>8</sub>		33- 3 <sup>3</sup> / <sub>8</sub>	150	210	270	

To above lengths add  $\frac{1}{2}$  inch for each end bushed and  $1\frac{1}{8}$  inches for each Hexagon Nipple used in assembling.

**M**ANY engineers maintain that railroad roundhouses should be equipped with blower systems, but nevertheless a great deal of Wall Radiation is used in this class of buildings. In many cases both systems are used.

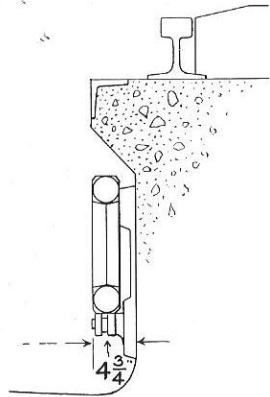

Fig. 136. AMERICAN Peerless Wall Radiator recessed inside wall of engine pit.

AMERICAN Peerless Wall Radiators are adapted excellently to roundhouse engine pits. They are narrow and, when mounted on ARCO Adjustable Wall Brackets, do not extend out more than  $4\frac{3}{4}$  inches from the wall. They serve particularly well when the heating surface in these engine pits is recessed.

AMERICAN Peerless Wall Radiator

“A” sections are only  $13\frac{5}{16}$  inches in height. Therefore a run of many of these sections, assembled end to end, may be set in an engine pit at a pitch that is sufficient to insure perfect drainage.

The new ARCO Adjustable Wall Bracket is perfectly suited for the work that is required of it. The fact that its adjustment may be accomplished after the Wall Radiators are set in place is exceedingly important. By reason of this feature the contractor using AMERICAN Peerless Wall Radiators finds that his labor item is agreeably reduced.

AMERICAN Peerless Wall Radiators, used in bathrooms, halls, kitchens, food-packing plants, butcher shops, restaurants, Turkish baths, laundries, lavatories, hospital operating rooms, sick wards, etc., leave a clear space beneath them which can be easily scrubbed or cleaned.

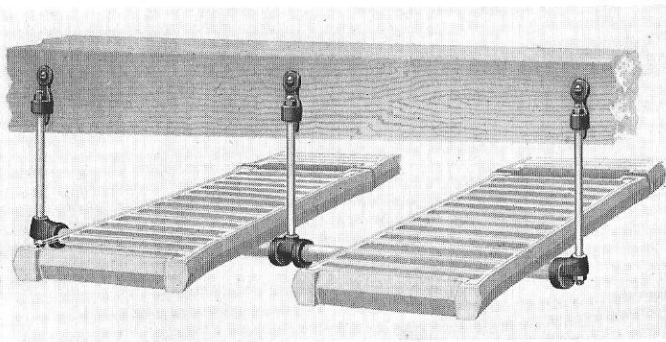

Fig. 137

**F**ACTORIES and many other buildings must have their utmost floor space available for machinery, benches, assembling platforms and other equipment. AMERICAN Peerless Wall Radiators permit the greatest conservation

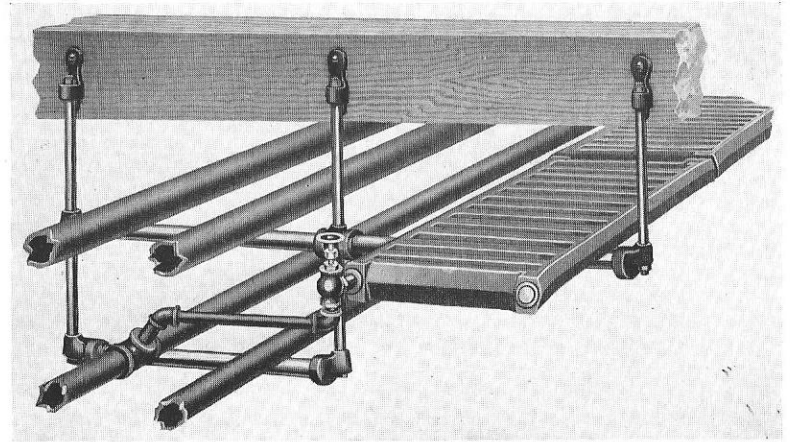

Fig. 138

of space, because they easily accommodate themselves to the building design by hanging from girders, in roof bays, light wells, etc., with the aid of the ARCO Trapeze and Slip End Supports shown in these typical installations.

**R**EALIZING the necessity for a change from the makeshift arrangements used for strapping or hanging pipe, conduits, radiators, etc., from ceilings, beams or girders, we have designed these ARCO Trapeze Supports with the view of furnishing a permanent as well as an adjustable and neat-appearing hanger.

Figs. 138, 152 and 153, on pages 26 and 30, show the ARCO Trapeze Support employed in hanging an AMERICAN Peerless Wall Radiator, with its supply and return pipes, in addition to plumbers' pipes.

Any arrangement or combination can be assembled on the job quickly by using standard nipples or cut pipe slipped over rods between Supports. The ARCO Slip End Supports, in conjunction with the single and double ARCO Trapeze Supports, permit many additional

combinations for hanging pipe, conduits, radiators, etc. The ARCO Slip End Supports shown in Fig. 142 replace the expensive and non-adjustable forged eye-bolts used in old-fashioned installations.

A few arrangements of these Supports are shown on pages 26, 30 and 45 to 47.

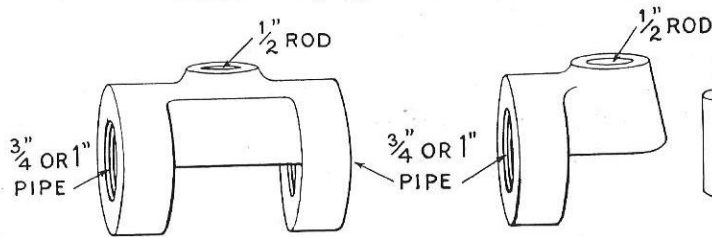

Fig. 139. ARCO Trapeze Support, Double. No. 2, with  $\frac{3}{4}$ -inch pipe thread; No. 4, with 1-inch pipe thread. (See page 28.)

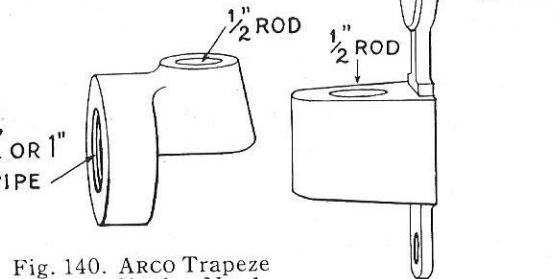

Fig. 140. ARCO Trapeze Support, Single. No. 1, with  $\frac{3}{4}$ -inch pipe thread; No. 3, with 1-inch pipe thread. (See page 28.)

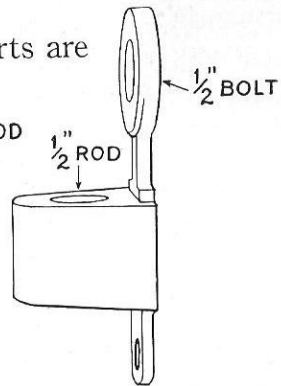

Fig. 141. ARCO Slip End Support No. 5. (See page 28.)

OFTEN it is highly desirable to employ AMERICAN Peerless Wall Radiators as *Ceiling Radiators*. Nothing detracts so greatly from the appearance of an installation as the employment of makeshift, insecure-appearing straps, bands, chains and the like, whereas the orderliness and neatness of the heating installation receive much favorable comment where the hanging of ceiling radiators and piping is simply and sturdily effected by use of these substantial and reliable ARCO Trapeze and Slip End Supports.

Besides, these ARCO Trapeze and Slip End Supports permit easy adjustment in pitch of piping and radiators or conduits at any time, whether to make up for irregularities in setting or in settling of the building.

The slight difference, if any, in cost is more than offset by the lower labor cost in erecting and adjusting these Supports.

A few examples of arrangements of these Supports are illustrated in pages 26, 30 and 45 to 47.

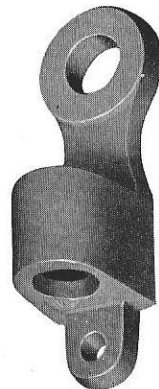

Fig. 142. ARCO Slip End Support, No. 5. For dimensions and threading of Slip End and Trapeze Supports, see pages 27 and 29.

Patents applied for

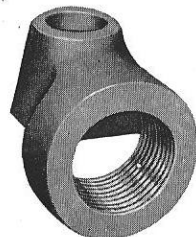

Fig. 143. ARCO Trapeze Support, Single, No. 1 or No. 3.

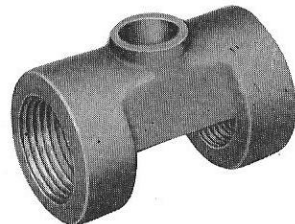
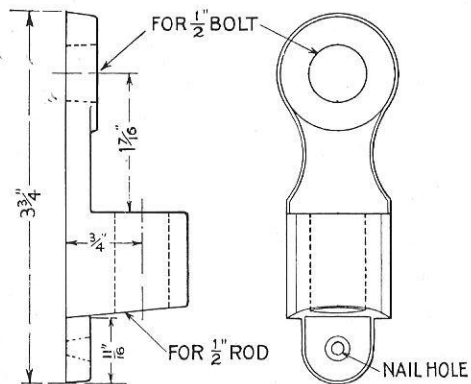

Fig. 144. ARCO Trapeze Support, Double, No. 2 or No. 4.



Figs. 145 and 146  
ARCO Slip End Supports, No. 5

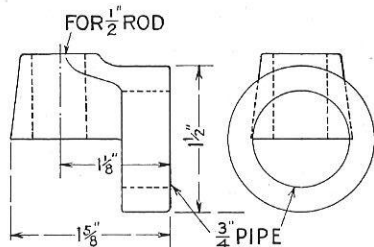

Fig. 147. ARCO Trapeze Support, Single, No. 1

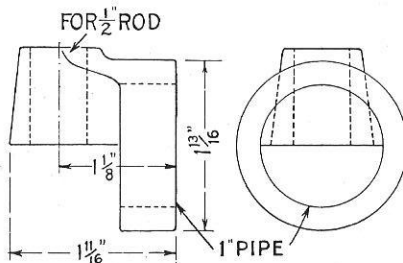

Fig. 148. ARCO Trapeze Support, Single, No. 3

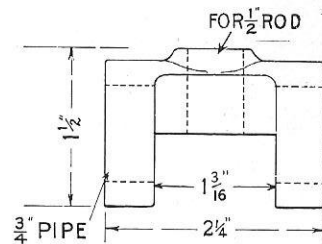

Fig. 149. ARCO Trapeze Support, Double, No. 2

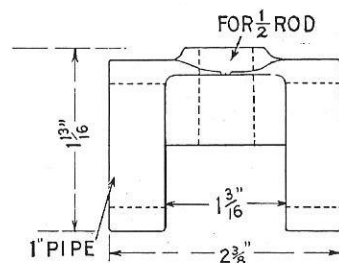

Fig. 150. ARCO Trapeze Support, Double, No. 4

ARCO Trapeze and Slip End Supports are made in dimensions as given, and as further illustrated and described on pages 26, 27, 28 and 30.

# Arco Trapeze and Slip End Supports, and Pendant Flights—Showing Application

AMERICAN PEERLESS  
WALL RADIATORS

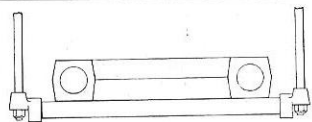

Fig. 151

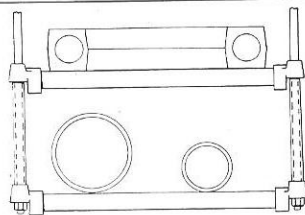

Fig. 153

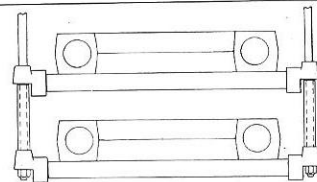

Fig. 154

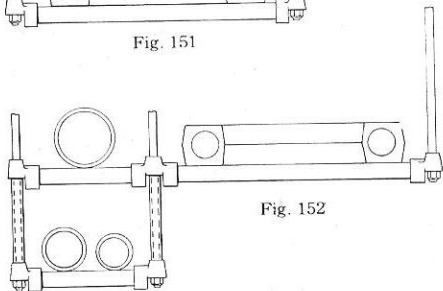

Fig. 152

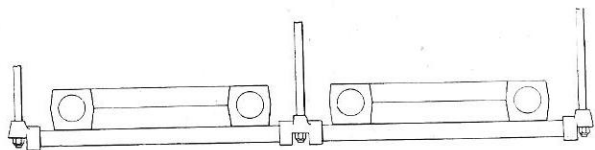

Fig. 155

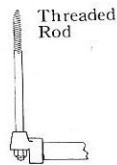

Fig. 156



Fig. 157



Fig. 158

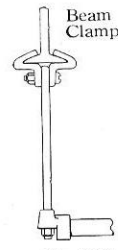

Fig. 159

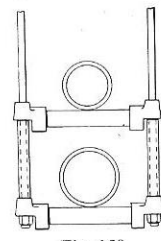

Fig. 160

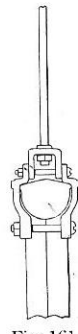

Fig. 161

NOTE: Dotted lines in Figs. 152-3-4 and 160 indicate rods run through short lengths of  $\frac{1}{2}$ -inch pipe, to afford whatever space may be determined upon for the placing of plumbing or other piping, conduits, etc. See also pages 26 to 29.

*Wall Radiators*—The wall radiators shown on this plan shall be of the AMERICAN Peerless pattern, as made by American Radiator Company.

*Wall Brackets*—AMERICAN Peerless Wall Radiators shall be supported on walls by the use of the ARCO Adjustable Wall Radiator Brackets, of the Single or Double Spool or of the ARCO Junior design.

*Ceiling Radiators*—The ceiling radiators shown on this plan shall be of the AMERICAN Peerless Wall pattern, as made by American Radiator Company.

*Ceiling Supports*—Where hung from ceilings, beams or joists, ARCO Adjustable Trapeze Supports, Slip Ends and Pendant Flights are to be used.

*Attachable Legs, Clearway Forms, Backset Connections*—If set on floor or used for railings, wall radiators are to be equipped with ARCO Attachable Legs. Where wall radia-

tors are used for railings, ARCO Attachable Legs will be used in upside-down fashion on the top of the radiator, and finish board or plate fastened thereto—all as shown in catalog Form No. KM100 of the American Radiator Company.

ARCO Clearway Forms are to be set in pilasters, as indicated on plan, and Backset Connections employed as necessary.

For Contractors' information, radiators are described on the plan as follows:

- W. R.—Wall Radiators
- C. R.—Ceiling Radiators
- P. F.—Hung Radiators
- A. L.—Floor Wall Radiators
- R. R.—Railing Radiators
- C. F.—Clearway Forms
- B. C.—Backset Connections



ARCO Clearway Forms, as shown on opposite page, have been successfully and economically used. When placed in a pier or pilaster, a clear pathway is made for the piping, thus overcoming the unsightly and expensive practice of elbowing around these projections. These forms should be delivered to the builder with instructions as to their positions. These are made to take up the height of two and three flat brick courses.

ARCO Clearway Forms can also be used on overhead piping where it is desired that pipes be out of the way of other apparatus.

Placing these Forms end to end at the center of the wall radiator tapplings enables units of any length to be made—all radiators between piers being connected together on

a straight line. ARCO Clearway Forms are made of cast iron, in three sizes, as listed on this page.

Where there are deeper recesses between piers or pilasters, the ARCO Backset Connections, as illustrated on page 35, offer a mechanically skillful means of neatly disposing of the radiators, causing them to hug the wall closely.

It should likewise be observed that use of Clearway Forms and Backset Connections carries circulation *through* uniformly and assists the air venting.

ARCO CLEARWAY FORMS  
Table of Dimensions

No.	Height Inches	Width Inches	Length Ft. In.
1	$4\frac{5}{8}$	$8\frac{5}{8}$	1-4 $\frac{3}{4}$
2	$4\frac{5}{8}$	$8\frac{5}{8}$	1-9
3	$4\frac{5}{8}$	$8\frac{5}{8}$	2-1

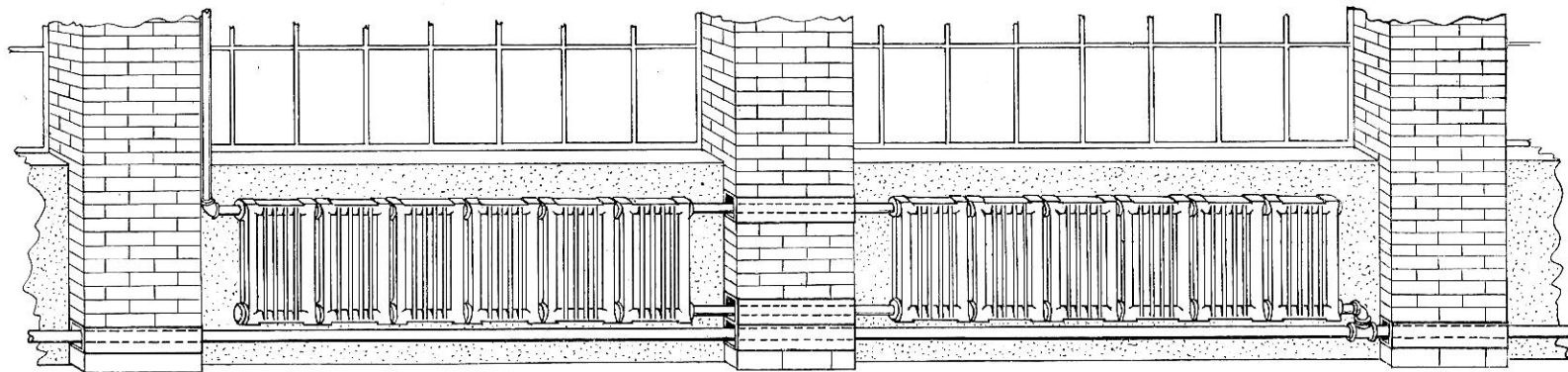

Fig. 162

A typical plan showing advantageous use of the ARCO Clearway Forms, offering clear pathways through piers or pilasters, to overcome the old-fashioned unsightly and expensive practice of elbowing around these building projections or of defacing a structure by rough attempts to channel across face of brick or concrete work. For table of sizes of ARCO Clearway Forms, descriptive text, etc., see page 32.

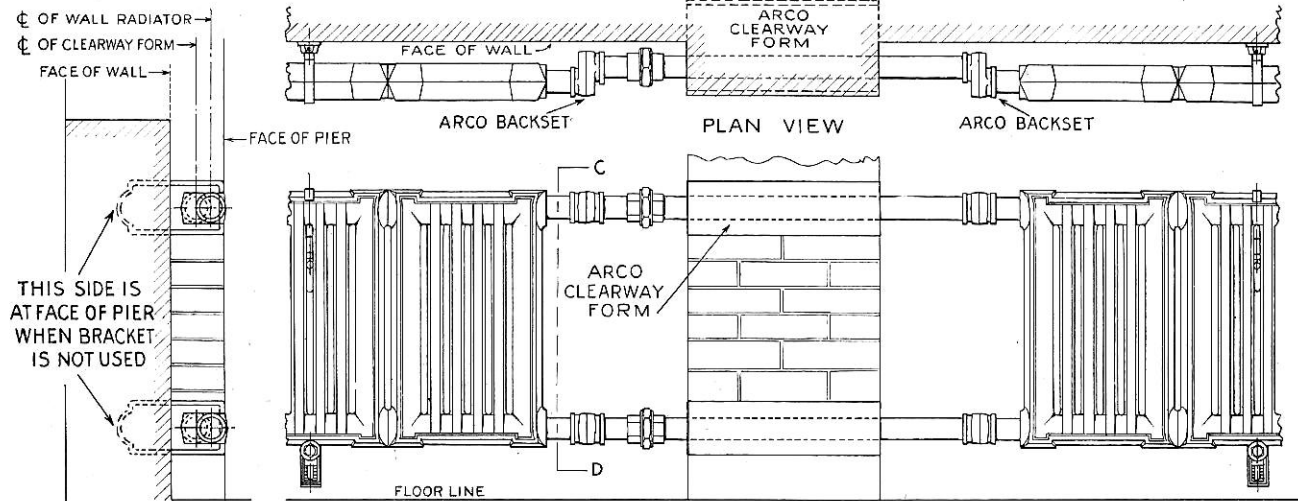
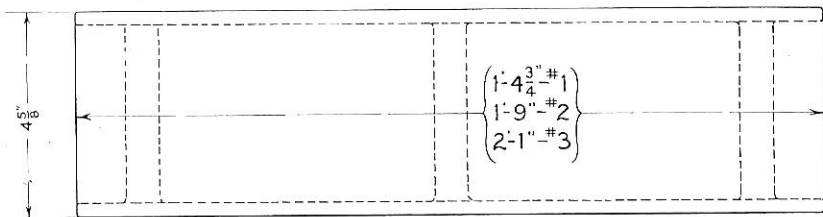
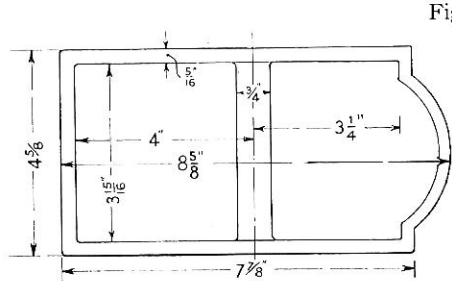

Fig. 163

Illustrates the advantageous employment of ARCO Backset Connections, in conjunction with ARCO Clearway Forms, to permit AMERICAN Peerless Wall Radiators to hug the wall closely in the recessed spaces between the piers or pilasters, particularly in the case of shallow pilasters. The ARCO Backset Connection carries the circulation *through* uniformly and assists the air venting. Made in 1½-inch size, measuring 2¾ inches in length and 1¼ inches between centers; and occupies 3¾ inches in width or backset. See also pages 33 and 35.



ELEVATION  
Fig. 164



SECTION  
Fig. 165

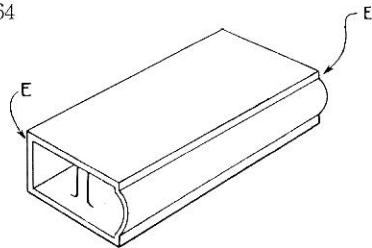

E. face of wall depending on  
which application is used  
Fig. 166

Outline measurements of ARCO Clearway Forms. For illustrations showing applications, see pages 33 and 34

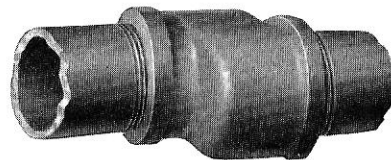

Patent applied for  
Fig. 167

ARCO Backset Connection, No. 1

Made in 1 1/2-inch size, measuring 2 3/4 inches in length, 1/4 inches between centers, and occupies 3 3/4 inches in width or backset

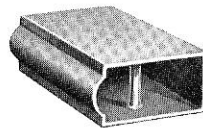
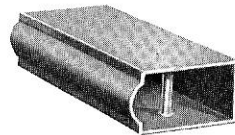

Fig. 168  
Size No. 1



Patent applied for  
Fig. 169  
Size No. 2

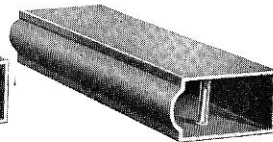

Fig. 170  
Size No. 3

THE ARCO Safety Concrete Insert is adaptable to a great variety of work where heavy equipment must be hung from concrete walls or ceilings. Its large base and large surface area insure great holding power. It is easily placed and held in the desired position and cannot be dislodged by the falling concrete while pouring the wall. The expanding shoe is sturdy enough to prevent the bolt from pulling out of the Insert.

Fig. 172, page 37, shows ARCO Safety Concrete Insert nailed, in position, to inside of wall form. Ready to pour concrete.

Fig. 173, page 37. Concrete has been poured, form stripped, nails clipped and bolt inserted into recess of the Insert, which lies imbedded in concrete with its face flush with the face of concrete wall.

Fig. 175, page 37. Expansion shoe has been opened (with a cold chisel) and bolt is now ready to carry ARCO Adjustable Brackets, and their complement of AMERICAN Peerless Wall Radiators. The best practice is to have these Inserts set as the concrete work progresses, and at the exact points designated on your blue prints. When building is ready for its heating equipment, it is easy to place bolt and expansion shoe in the Insert, and hang the AMERICAN Peerless Wall Radiators thereon.

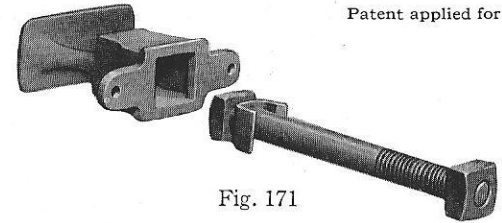

Fig. 171

ARCO Safety Concrete Insert, with bolt and expansion shoe ready for insertion.

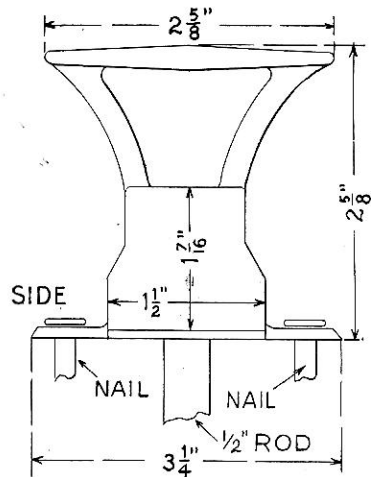

Fig. 172

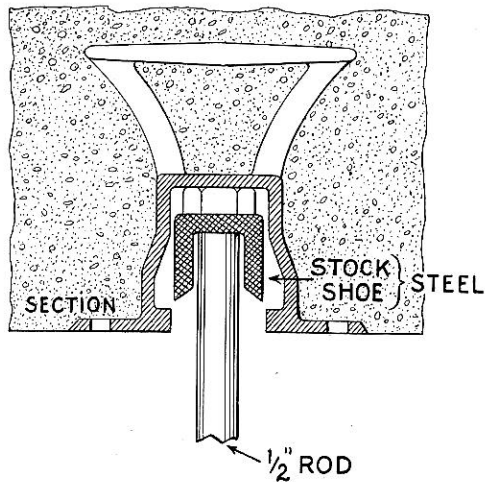

Fig. 173

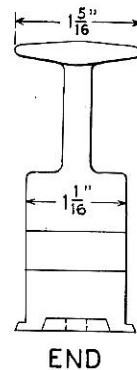

Fig. 174

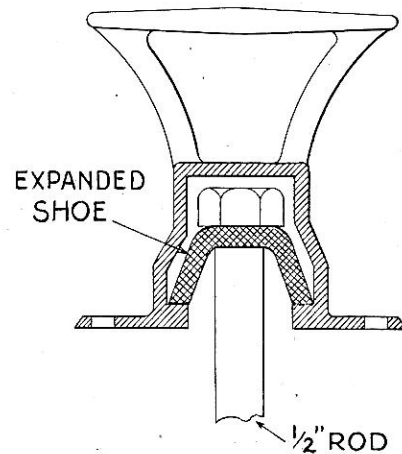
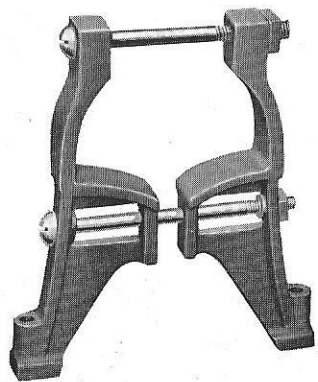

Fig. 175

Made in one size only,  $2\frac{5}{8}$  inches deep, by  $3\frac{1}{4}$  inches across face. For further illustration and descriptive text, see page 36. Reverse position of the bolt head, or use bolt threaded double-end, if desirable later to remove bolt.



Patent applied for

Fig. 176. No. 1 ARCO Attachable Leg (or Shelf Support) for Single Section or Single Row of AMERICAN Peerless Wall Radiators.

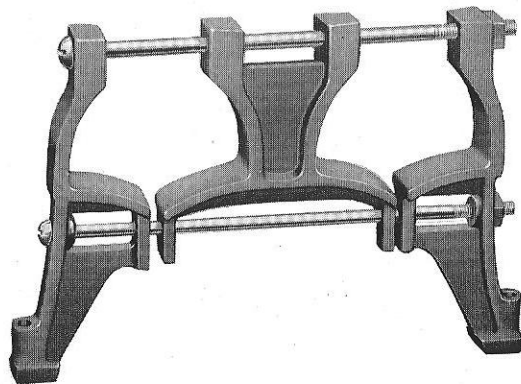

Patent applied for

Fig. 177. No. 2 ARCO Attachable Leg (or Shelf Support) for Double Row of AMERICAN Peerless Wall Radiators. For dimensions and illustrations of suggested use, see pages 39, 40 and 42 to 47.

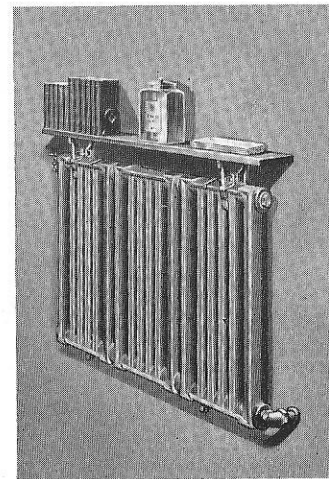

Fig. 178. ARCO Attachable Legs inverted and used as a shelf support. When shelf or rail is made to fit close to wall, acts as a wall shield as well as a convenient rail or bracket.

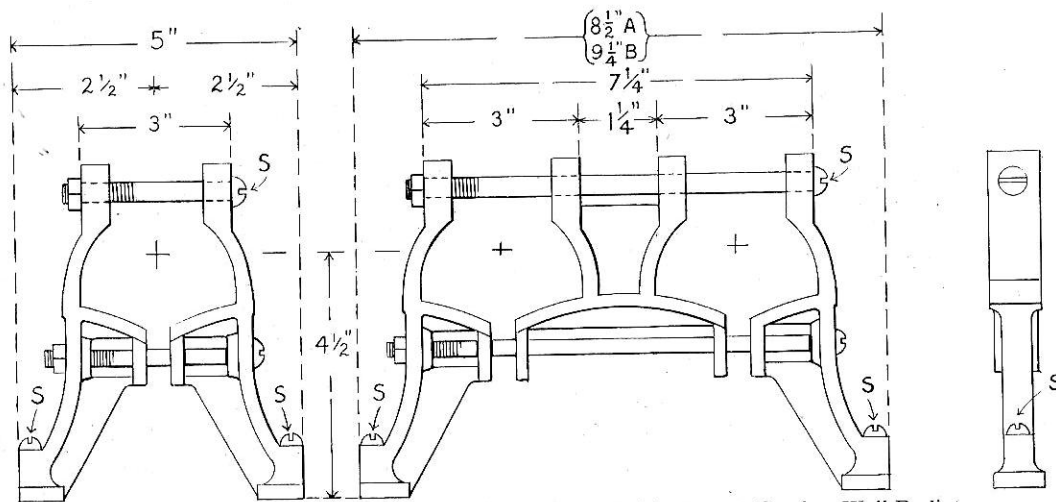

Fig. 179-A. ARCO Attachable Leg, carrying single row of AMERICAN Peerless Wall Radiator;  
and Fig. 179-B (at right), carrying double row.

**A**RCO Attachable Legs for AMERICAN Peerless Wall Radiators are made of malleable iron, and are so arranged as to finish at  $4\frac{1}{2}$  inches from floor to center of tapping. Radiators of five sections or less of the 7-B and 9-B type to have two Legs; of the 9-A, two Legs for three sections; of 7-A, two Legs for four sections; of 5-A, three Legs for five sections.

The number of ARCO Attachable Legs for each Radiator will be the same as shown for the Single and Double ARCO Adjustable Wall Brackets as shown in tables on pages 17 and 18.

For longer Radiators add one Leg for each five sections of 7-B and 9-B and



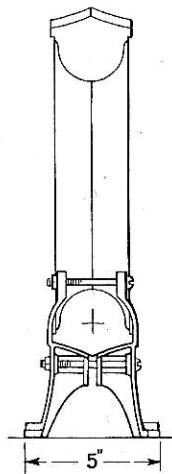

Fig. 180  
Single

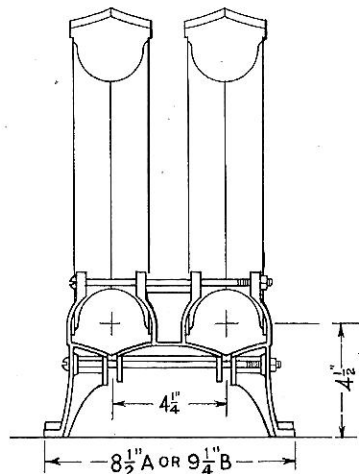

Fig. 181  
Double  
Sections through Radiator at Leg.

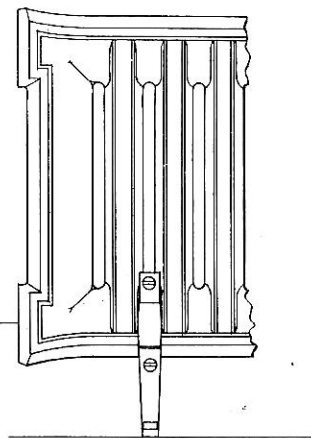

Fig. 182  
Showing application

one for each three sections of 9-A, four sections of 7-A and five sections of 5-A or less.

When AMERICAN Peerless Wall Radiators are used as a railing, the top may be left plain or, if desired, an extra set of Legs or Supports can be run along the top, and on to this a wood or other railing top can be placed. When shelf or rail is made to fit close to wall, it acts as a wall shield as well as a convenient rail or bracket.

A further use for AMERICAN Peerless Wall Radiators is in apartments where they will set in close to the wall,  $4\frac{3}{4}$  inches being the distance from back line to face of Radiator.

For sizes and dimensions, see cut on this page and page preceding.

**A**RCO Pendant Flights, as illustrated on this page and in the typical installation views in Figs. 191 and 192, afford an admirable means of suspending AMERICAN Peerless Wall Radiator sections in the roof bays, or in skirting the skylights, or like places, to meet and offset the cold and chill drafts and at the same time leave much of the valuable floor space free and unencumbered.

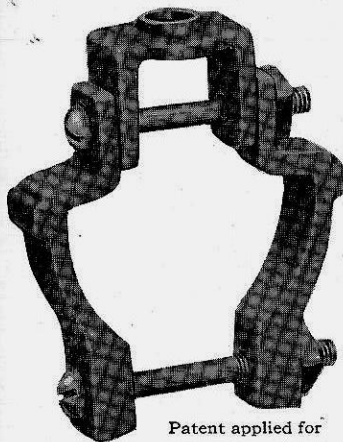

Patent applied for  
Fig. 183. ARCO Pendant Flight.

ARCO Pendant Flights fit snugly to the mid-contour of AMERICAN Peerless Wall Radiator sections, as shown by Fig. 184, at right of this page. The opening at top of the ARCO Pendant Flights accommodates a  $\frac{1}{2}$ -inch rod—the rod extending to and being made fast to the framework of the roof or to clamp to “I” beam, as illustrated in Figs. 191 and 192, page 45.

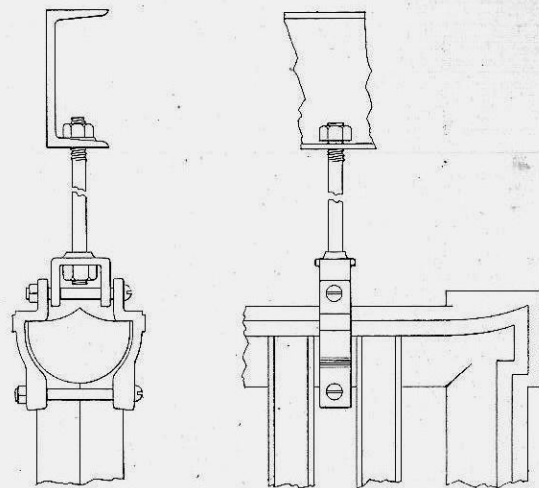

Fig. 184. End and side view of ARCO Pendant Flight, attached to AMERICAN Peerless Wall Radiator Section.

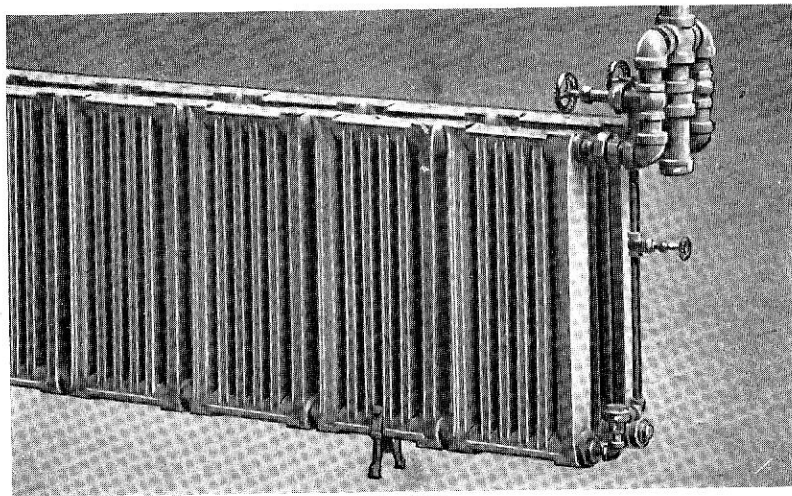

Fig. 185

Illustrating effective arrangement of double row of AMERICAN Peerless Wall Radiators and piping (before partition is put in place) with double valving, affording refinement in heat control.

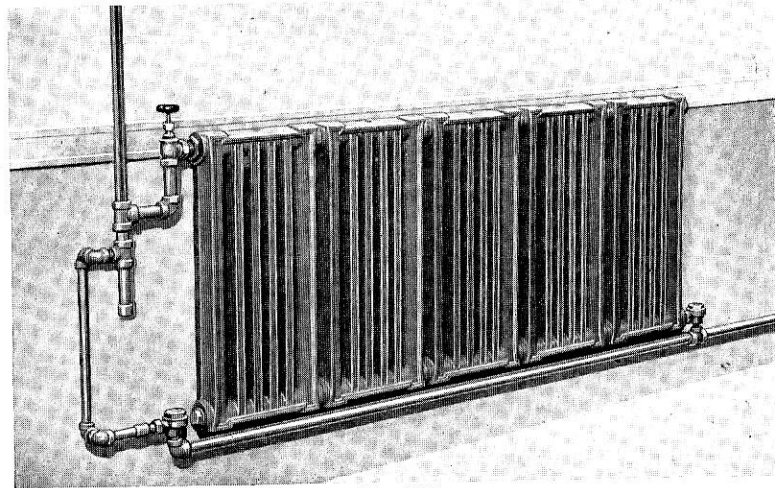

Fig. 186

Typical installation, illustrating the simple, neat, out-of-the-way arrangement of AMERICAN Peerless Wall Radiators and piping. The face of the radiators projects only  $4\frac{3}{4}$  inches from the wall with use of ARCO Adjustable Single-Spool Bracket.

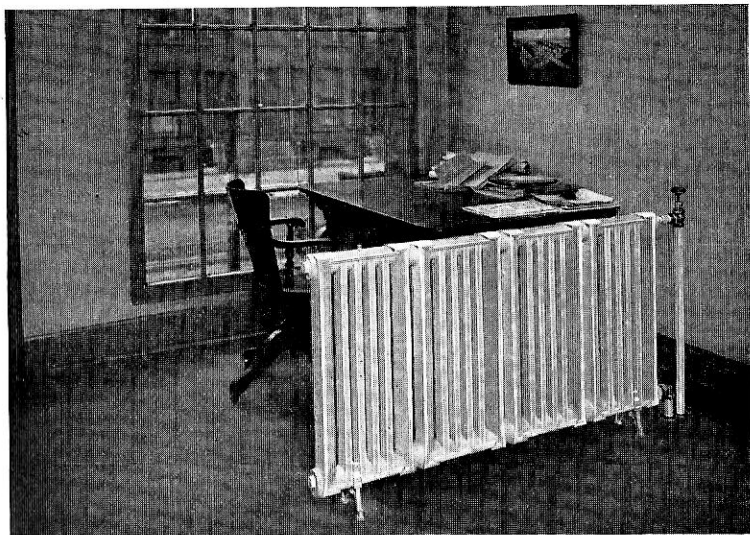

Fig. 187

Figs. 187 and 188. Illustrating AMERICAN Peerless Wall Radiators with ARCO Attachable Legs. In the Figure at the right the ARCO Attachable Legs are also cleverly employed as supports for wood or marble shelf or rail. See also illustrations on page 44, and outline drawings, giving Leg measurements on page 40.

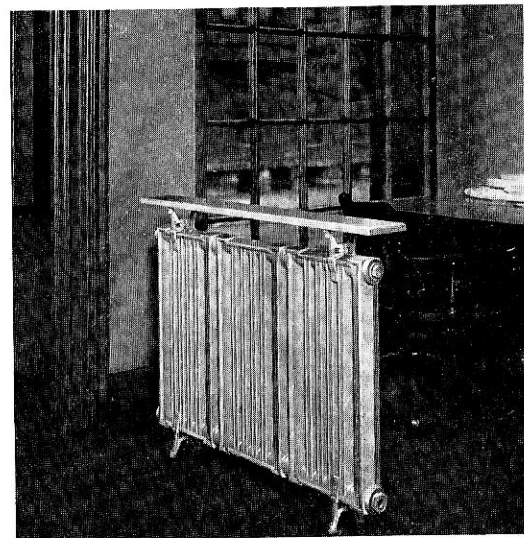

Fig. 188

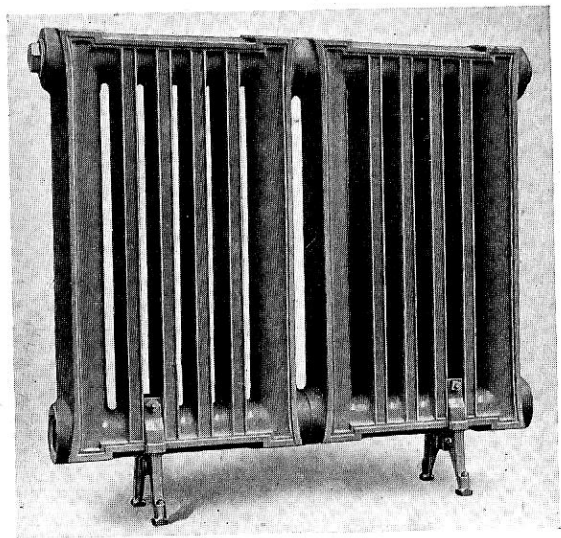

Fig. 189

Figs. 189 and 190. Illustrating single and double rows of AMERICAN Peerless Wall Radiators on ARCO Attachable Legs. For description and measurements, see pages 39 and 40.

See also illustration on page 42, showing double valving and piping, and which permits the employment of either or both stacks, to suit the heating needs of the milder winter days, or to meet sub-zero days.

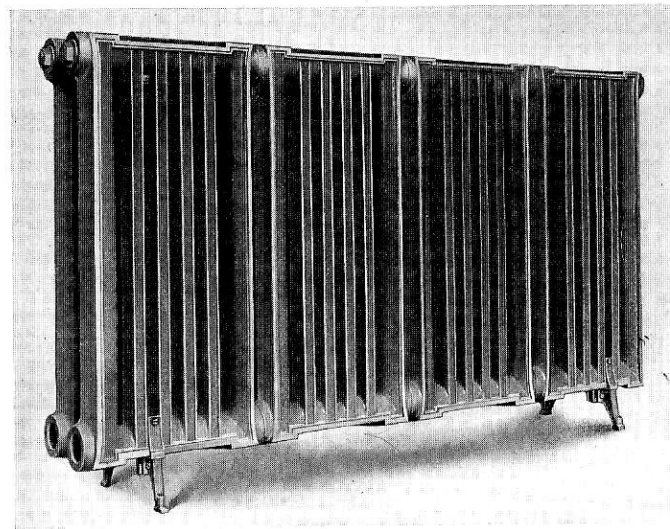

Fig. 190

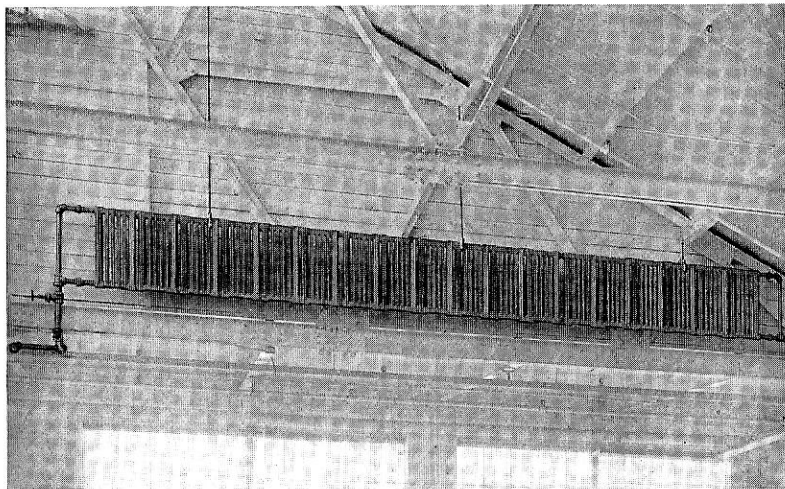

Fig. 191

Illustrating how AMERICAN Peerless Wall Radiators in saw-tooth bay are held in suspension by ARCO Pendant Flights. (See page 41.)

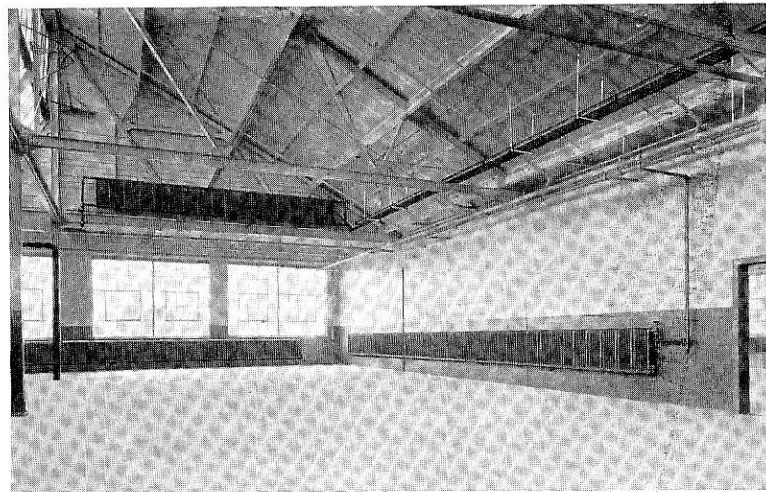

Fig. 192

Shows various assemblages of Wall Radiators carried by ARCO Adjustable Trapeze Supports, from ceiling, and held up, out of the way, on partition and under side-windows by ARCO Adjustable Wall Brackets.

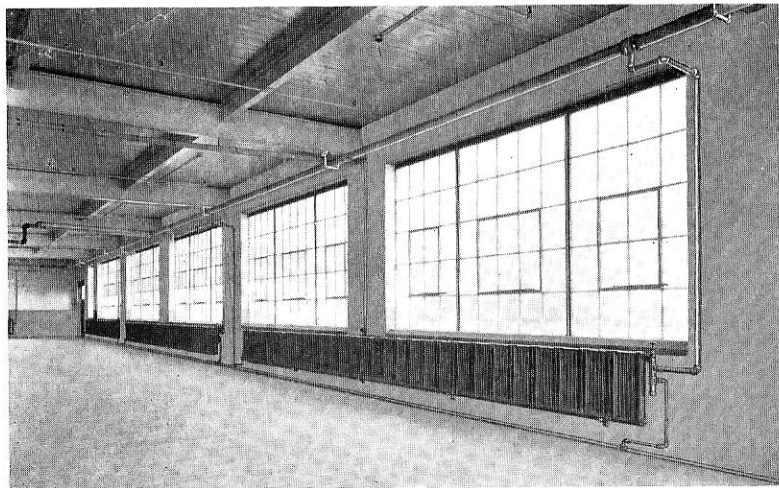

Fig. 193

Illustrating how AMERICAN Peerless Wall Radiators are placed effectively but entirely out of the way of workers and operations. Note ARCO Adjustable Trapeze Supports on ceiling supply pipe.

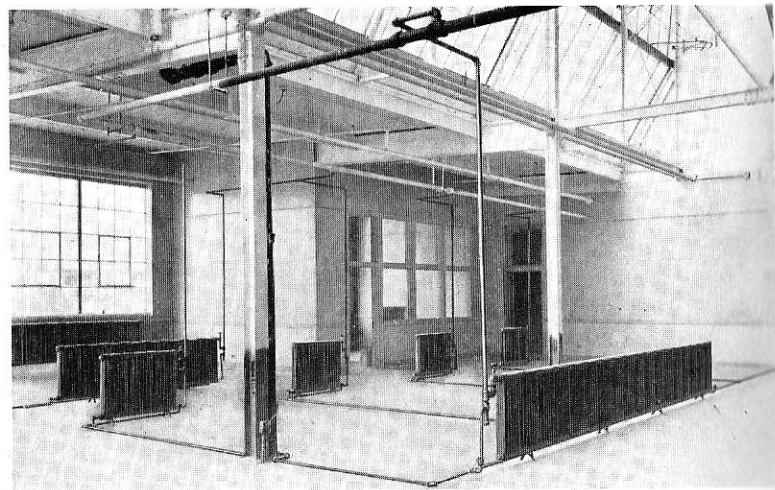

Fig. 194

Illustrating AMERICAN Peerless Wall Radiators on ARCO Attachable Legs set in position before room partitions are placed. Note the large and varied range of heating surface assemblages, and the ease of adjusting radiators and piping to present or future needs.

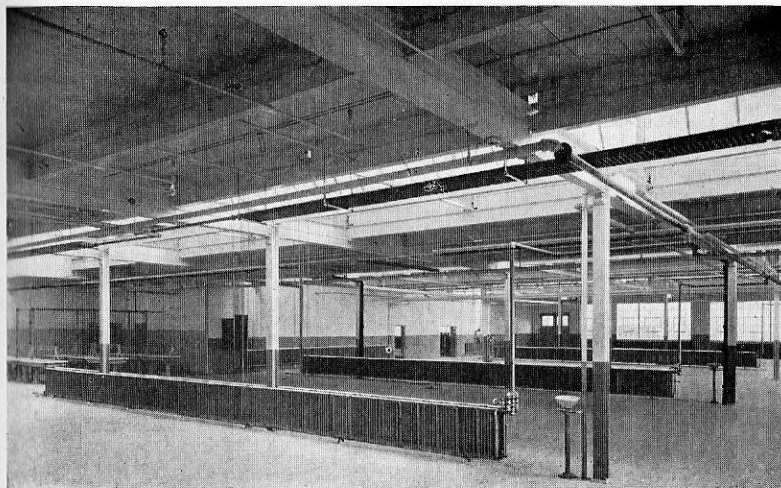

Fig. 195

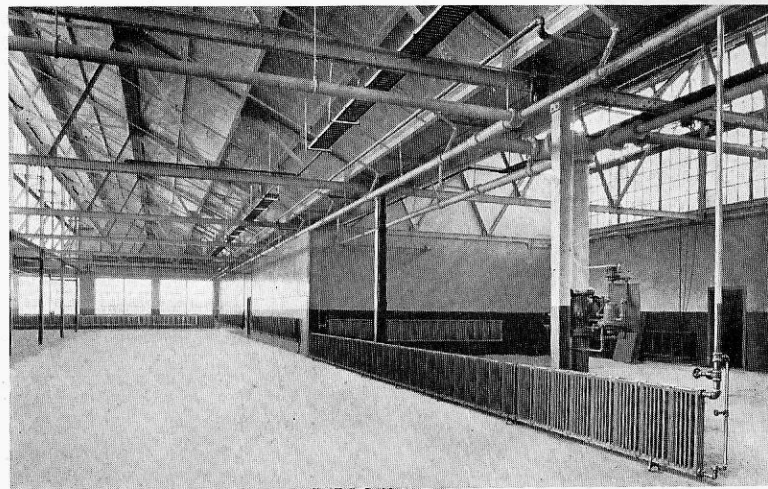

Fig. 196

Note the effective placing of AMERICAN Peerless Wall Radiators in skylights, also double and single rows of Radiators on ARCO Attachable Legs before wire partitions are placed. Also note ARCO Adjustable Trapeze Supports on ceiling. Note that both the single and double rows of AMERICAN Wall Radiators are over 50 feet in length and in perfect alignment. Can be readily adjusted to "fence off" any departmental floor needs, present or future, or hung as and where needed in bays or skylights, or on walls and around columns.



## Typical Installations

AMERICAN PEERLESS  
WALL RADIATORS

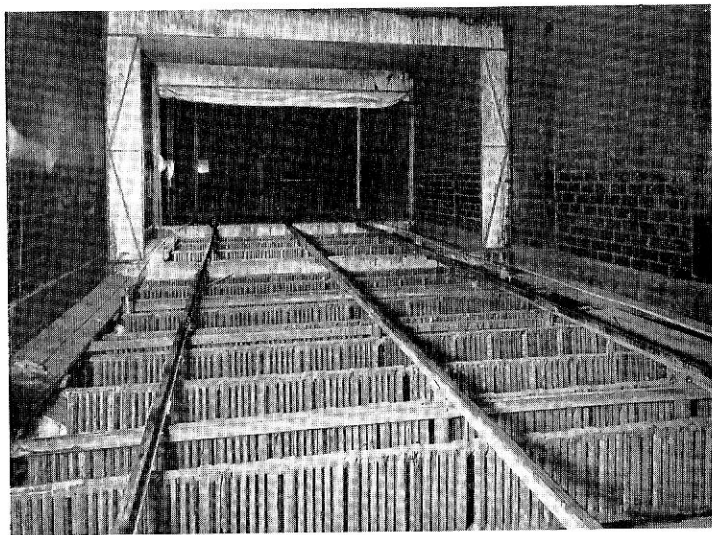

Fig. 197

Illustrating a typical installation of AMERICAN Peerless Wall Radiators in kiln drying-room of a leading manufacturer of automobiles.

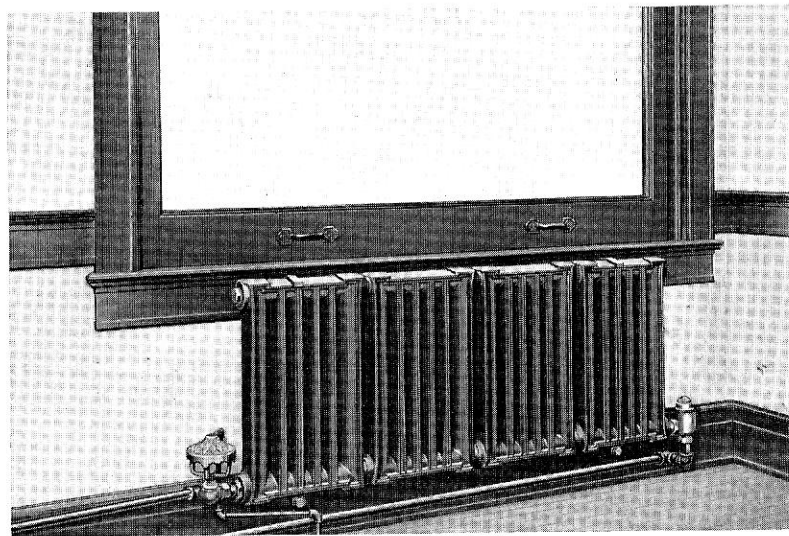

Fig. 198

Illustrating a typical neat, effective, out-of-the-way installation of AMERICAN Peerless Wall Radiators under window in skyscraper office building.

**I**N factories AMERICAN Peerless Wall Radiators serve many purposes other than heating. Through their use liquids in tanks may be kept at any desired working temperatures. Pipe coils in such tanks often are quickly destroyed by chemical action which these Cast-Iron Wall Radiators resist. Wall Radiators are much used in drying rooms of all kinds.

Yachts, house-boats, boat-houses, public and private garages, small summer cottages, lodges, mine and factory wash-houses, chemical works, and other places where acid fumes are in evidence, are a few of the many places that have limited

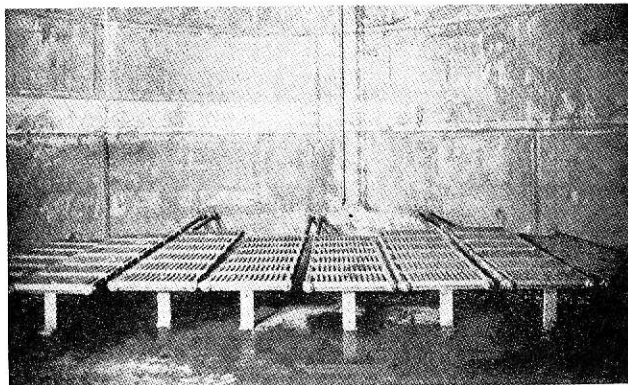
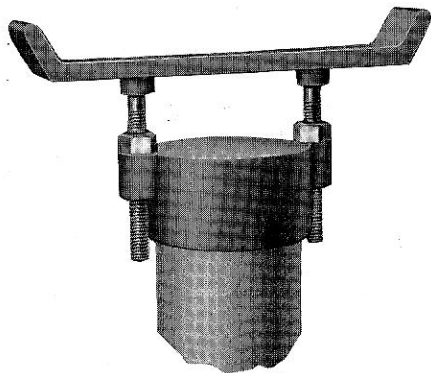

Fig. 199. AMERICAN Peerless Wall Radiators used to heat creosote in a railroad tie creosoting tank.

spaces for heating surface. They can best be heated by AMERICAN Peerless Wall Radiators, in combination with the ARCO Brackets, Supports, Hangers, Inserts, Attachable Legs, Pendant Flights, Clearway Forms and Backset Connections herein illustrated and listed.

The appointment of a competent engineer to cooperate with the architect during preparation of the building plans and specifications is an act of wisdom on the part of the owner. Such action insures him not only the plant best suited to his requirements but also the one involving the greatest economy in first cost as well as in operation.

**A**RCO Greenhouse Radiator Post Supports give to greenhouse men a long-sought, permanent means of installing radiator heating surfaces under benches, and insure a construction doing away with the vexatious, costly troubles from sagging, trapped coils and split headers.



Patent applied for  
Fig. 200. ARCO Greenhouse Post Support, No. 1.

These Supports are made in size to cap a 5-inch concrete molded post. (See Fig. 201, page 50.) The two ears, with their  $\frac{5}{8}$ -inch rods, uphold the ARCO heavy cast-iron saddles, upon which rest the stacks of AMERICAN Peerless Wall Radiators. The threaded rods permit raising or lowering the saddles, to insure correct drainage of heating surfaces and piping as long as the greenhouse lasts.

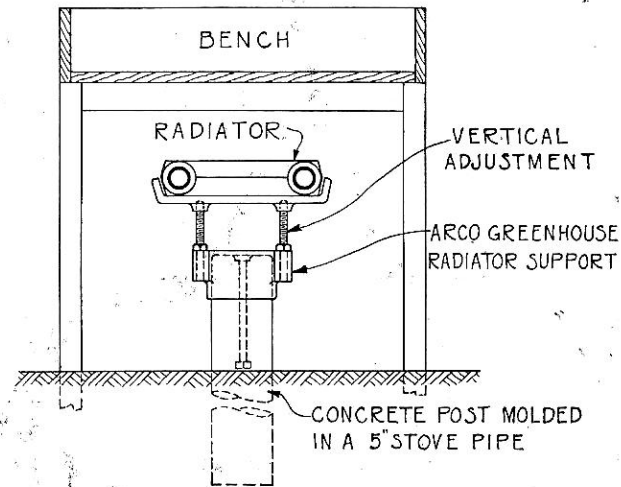

Fig. 201. End View of Bench.  
See also Plan View of Benches, etc., on opposite page.

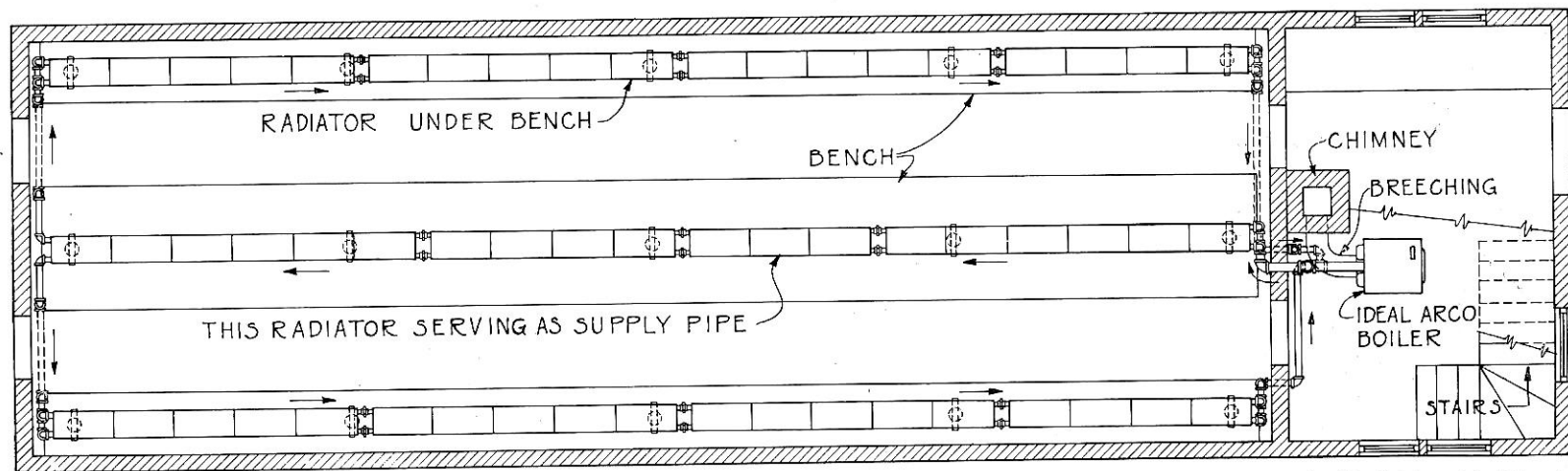

Fig. 202. Plan of typical greenhouse, showing runs of AMERICAN Peerless Wall Radiators placed under benches, in stacks connected with right- and left-hand threaded hexagon nipples. Dotted lines indicate where the ARCO Greenhouse Radiator Post Supports are placed to uphold the stacks of Radiators, and as further illustrated and described on page 50. Radiators shown on this plan are of the "B" type, which in this arrangement offer freer circulation of the heating medium.

**M**ORE than fifty thousand installations of AMERICAN Peerless Wall Radiators have been made in about every form or class of structure or place that can be imagined. This large number of shipments precludes the showing of a complete list here. In these installations more than thirty million square feet of AMERICAN Peerless Wall Radiators are used. A special list of installations in any specified locality will be supplied on application.

AMERICAN Peerless Wall Radiators for heating, cooling, drying or curing are used in:

Arcades	Conservatories	Gymnasiums	Printing houses	Stores
Art galleries	Depots	Hotels	Restaurants	Street-car barns
Asylums	Distilleries	Interlocking R. R. towers	Residences	Sun-rooms of hospitals
Auditoriums	Dock offices	Laundries	Rope-walks	Sun-rooms of hotels
Automobiles	Dry kilns	Libraries	R. R. roundhouses	Tanks, vats, etc.
Battleships	Dyeing works	Machine shops	R. R. waiting-rooms	Tanneries
Barns	Factories	Mills	Sanitariums	Theaters and studios
Book binderies	Fire Dept. towers	Movies and studios	School buildings	Tobacco barns
Bowling alleys	Fire engine houses	Oil refineries	Ships' cabins	Turkish baths
Breweries	Freight houses	Offices and banks	Skating rinks	Warehouses
Churches	Garages	Photograph galleries	Steamships	Weighing-rooms
Commission warehouses	Greenhouses	Post-offices	Storage warehouses	Yachts, etc., etc.

This Company cordially invites requests for special information covering the heating, drying, cooling and ventilating needs of these and other classes of buildings or processes. Also ask for special "*Refrigeration*" catalog.

**H**IGHER Working Pressures—AMERICAN Peerless Wall Radiators are regularly tested at the factory at from 100 to 120 pounds cold water pressure, but where higher working pressures (steam or water) than 40 pounds are required order must specifically so state. In these cases wall radiators are furnished only with outside hexagon nipples.

For Convenience in Handling and Shipping in *less than car-load lots*, unless otherwise ordered, No. 5-A Radiators will be assembled in stacks not exceeding six sections; No. 7-A Radiators in stacks not exceeding four sections; No. 9-A Radiators in stacks not exceeding three sections; and Nos. 7-B and 9-B Radiators in stacks not exceeding seven sections. See page 54 for schedule of shipping Wall Radiators in stacks or units, as followed in our factory practice, unless otherwise ordered.

**When Erecting Large Stacks**—When fitter intends to erect a stack consisting of more sections than above mentioned, or when the sections or stacks are to be set in rows or series (as shown by illustrations on pages 58 to 60), we provide a right- and left-hand threaded nipple *having hexagon nut at center*, enabling the fitter easily to connect the stacks or rows on the job.

The 1½-inch right- and left-hand threaded internal nipples have two heavy inside lugs so that an ordinary piece of 1-inch round iron, flattened at one end the length of nipple, can be inserted to any desired point in the Radiator, and by applying an ordinary wrench to bar the nipple can be **screwed or unscrewed** and one or more sections may be **added or taken out**. We can furnish these bars (Direct Radiator Wrenches) in 4-foot lengths.

# Shipping Wall Radiators in Units or Stacks

AMERICAN PEERLESS  
WALL RADIATORS

IT is our practice to ship AMERICAN Peerless Wall Radiators in stacks, as explained on page 53. To assist customers we append schedule of shipping units or stacks as practiced by us, unless otherwise ordered.

7- and 9-B Wall Radiators									
Sections	Units			Sections	Units				
8	1-4	1-4		22	1-6	1-6	1-6	1-4	
9	1-5	1-4		23	1-6	1-6	1-6	1-5	
10	1-5	1-5		24	1-6	1-6	1-6	1-6	
11	1-6	1-5		25	1-7	1-6	1-6	1-6	
12	1-6	1-6		26	1-7	1-7	1-7	1-5	
13	1-7	1-6		27	1-7	1-7	1-7	1-6	
14	1-7	1-7		28	1-7	1-7	1-7	1-7	
15	1-5	1-5	1-5	29	1-6	1-6	1-6	1-6	1-5
16	1-5	1-6	1-5	30	1-6	1-6	1-6	1-6	1-6
17	1-6	1-5	1-6	31	1-7	1-6	1-6	1-6	1-6
18	1-6	1-6	1-6	32	1-7	1-7	1-6	1-6	1-6
19	1-6	1-7	1-6	33	1-7	1-7	1-7	1-6	1-6
20	1-7	1-6	1-7	34	1-7	1-7	1-7	1-7	1-6
21	1-7	1-7	1-7	35	1-7	1-7	1-7	1-7	1-7

Radiators 7 sections and under shipped in one unit.

7-A Wall Radiators					
Sections	Units				
5	1-3	1-2			
6	1-3	1-3			
7	1-4	1-3			
8	1-4	1-4			
9	1-3	1-3	1-3		
10	1-4	1-2	1-4		
11	1-4	1-3	1-4		
12	1-4	1-4	1-4		
13	1-4	1-3	1-3	1-3	
14	1-4	1-4	1-3	1-3	
15	1-3	1-3	1-3	1-3	1-3
16	1-4	1-4	1-4	1-4	
17	1-4	1-4	1-3	1-3	1-3
18	1-4	1-4	1-4	1-3	1-3
19	1-4	1-4	1-4	1-4	1-3
20	1-4	1-4	1-4	1-4	1-4

Radiators 4 sections and under shipped in one unit.

9-A Wall Radiators							
Sections	Units						
4	1-2	1-2					
5	1-3	1-2					
6	1-3	1-3					
7	1-3	1-2	1-2				
8	1-3	1-3	1-2				
9	1-3	1-3	1-3				
10	1-3	1-3	1-2	1-2			
11	1-3	1-3	1-3	1-2			
12	1-3	1-3	1-3	1-3			
13	1-3	1-3	1-3	1-2	1-2		
14	1-3	1-3	1-3	1-3	1-2		
15	1-3	1-3	1-3	1-3	1-3		
16	1-3	1-3	1-3	1-3	1-2	1-2	
17	1-3	1-3	1-3	1-3	1-3	1-2	
18	1-3	1-3	1-3	1-3	1-3	1-3	
19	1-3	1-3	1-3	1-3	1-3	1-2	1-2
20	1-3	1-3	1-3	1-3	1-3	1-3	1-2

Radiators 3 sections and under shipped in one unit.

**K**EY to Figure Numbering—Orders should refer to figure number showing assemblage. (See pages 56 to 60.) The first numeral in each of the following figure numbers indicates the size of section, thus: Fig. 511 means 5-foot sections arranged in the manner as shown in sketch above the number; Fig. 711 refers to 7-foot sections and to the same assemblage; and Fig. 911 refers to 9-foot sections and to the same assemblage.

**Assemblages**—Sections are always assembled with bars vertical for greatest heating efficiency. The figures shown on these pages illustrate the common ways of assembling comparatively small units, but AMERICAN Peerless Wall Radiators can be assembled in any number of sections, either longer or higher than shown in the figures. It is

our practice, however, when a greater number of sections are specified than exactly shown in the figure, always to build on to the length, maintaining the height as shown in the figure. The safe way in ordering is always to send sketch unless you are ordering exactly the number of sections as shown in the figure.

**Regular and Special Tappings**—The regular tappings of AMERICAN Peerless Wall Radiators, as shown on the following pages, are indicated by Nos. 2, 3, 4, 5, 6, 7, 8 and 9. Nos. 20, 30, 40, 50, 60, 70, 80 and 90 indicate special tappings which can be furnished if desired and for which an extra charge will be made. Tappings are 1½ inches, supply and return, and bushed as desired. See also “Directions for Ordering,” page 53.



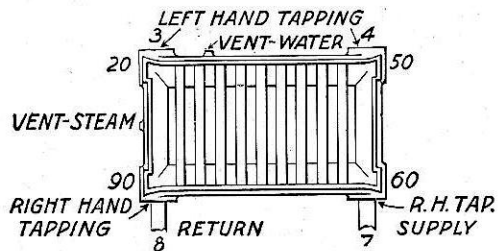

Fig. 51, 71 or 91.

Water and One- and Two-Pipe Steam.

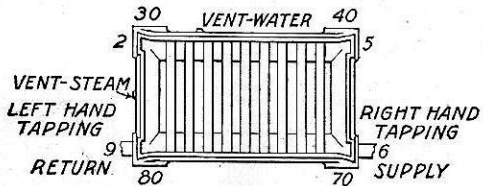

Fig. 57, 77 or 97.

Water and One- and Two-Pipe Steam.

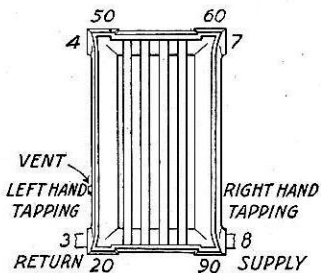

Fig. 74 or 94.

One- and Two-Pipe Steam.

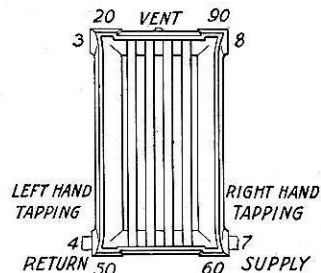

Fig. 78 or 98.

Water.

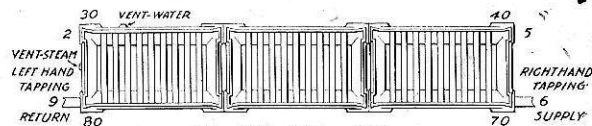

Fig. 511, 711 or 911.

Assembled Three Sections in Single Tier—Water and One- and Two-Pipe Steam.

See notes on Assemblages and Tappings, page 55.

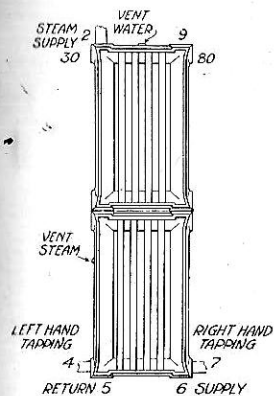

Fig. 713 or 913.  
Two Sections in Two Tiers  
—Water and Two-Pipe  
Steam.

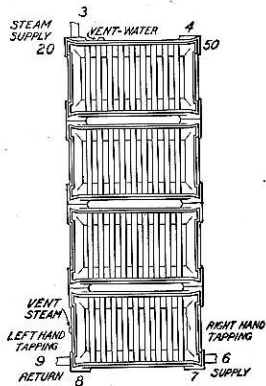

Fig. 515, 715 or 915.  
Assembled Four Sections in  
Four Tiers—Water and  
Two-Pipe Steam.

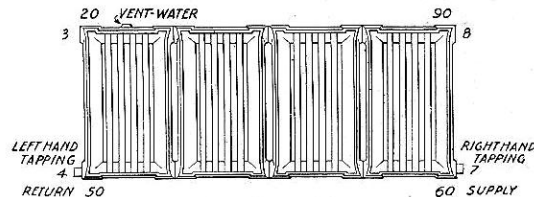

Fig. 717 or 917.  
Assembled Four Sections in Single Tier—Water.

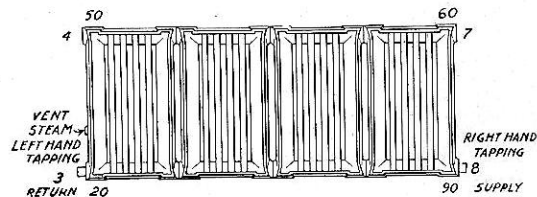

Fig. 718 or 918.  
Assembled Four Sections in Single Tier—One- and Two-Pipe Steam.

See notes on Assemblages and Tappings, page 55.

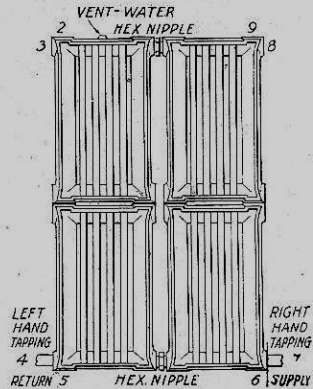

Fig. 719 or 919.  
Assembled Four Sections in Two Tiers—  
Water.

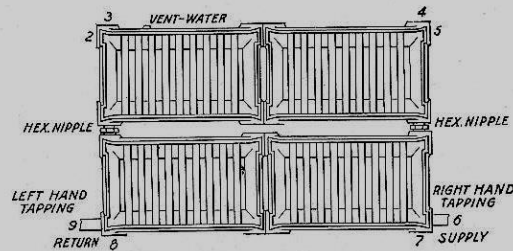

Fig. 521, 721 or 921.  
Assembled Four Sections in Two Tiers—Water.

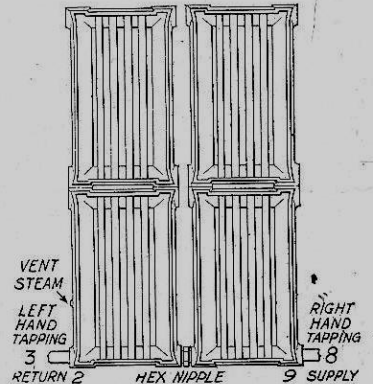

Fig. 720 or 920.  
Assembled Four Sections in Two Tiers—  
One- and Two-Pipe Steam.

See notes on Assemblages and Tappings, page 55.

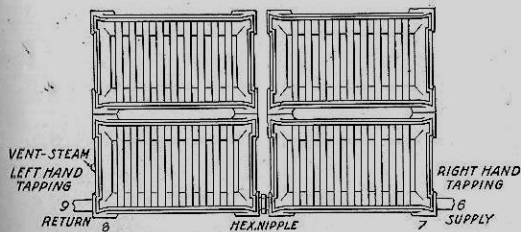

Fig. 522, 722 or 922.  
Assembled Four Sections in Two Tiers—  
One- and Two-Pipe Steam.

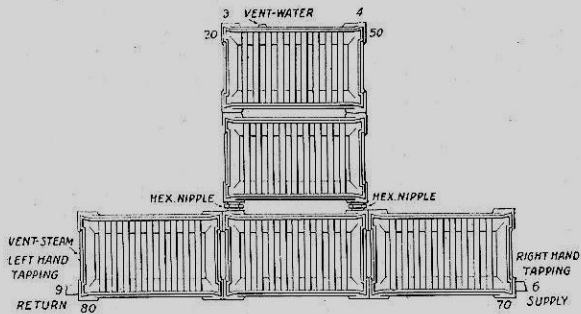

Fig. 523, 723 or 923.  
Assembled Three and Two Sections with Three Tiers in  
Center—Water and One- and Two-Pipe Steam.

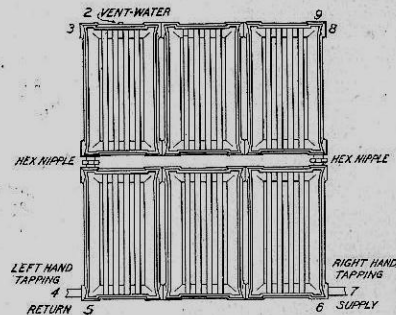

Fig. 725 or 925.  
Assembled Six Sections in Two Tiers—  
Water.

See notes on Assemblages and Tappings, page 55.

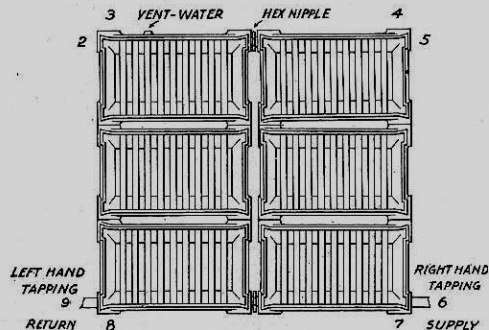

Fig. 527, 727 or 927.

Assembled Six Sections in Three Tiers—Water.

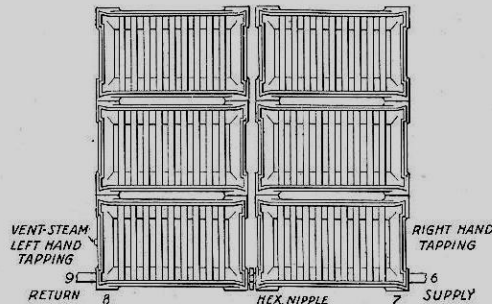

Fig. 528, 728 or 928.

Assembled Six Sections in Three Tiers—One- and Two-Pipe Steam.

DECIMAL EQUIVALENTS

$\frac{1}{64}$	.0156	$\frac{23}{64}$	.3593	$\frac{45}{64}$	.7031
$\frac{1}{32}$	.0312	$\frac{3}{8}$	.375	$\frac{47}{64}$	.7187
$\frac{2}{64}$	.0468	$\frac{25}{64}$	.3906	$\frac{49}{64}$	.7343
$\frac{1}{16}$	.0625	$\frac{13}{32}$	.4062	$\frac{3}{4}$	.75
$\frac{3}{64}$	.0781	$\frac{27}{64}$	.4218	$\frac{49}{64}$	.7656
$\frac{4}{64}$	.0937	$\frac{7}{16}$	.4375	$\frac{25}{32}$	.7812
$\frac{5}{64}$	.1093	$\frac{29}{64}$	.4531	$\frac{37}{64}$	.7968
$\frac{1}{8}$	.125	$\frac{15}{32}$	.4687	$\frac{51}{64}$	.8125
$\frac{6}{64}$	.1406	$\frac{31}{64}$	.4843	$\frac{13}{16}$	.8281
$\frac{7}{64}$	.1562	$\frac{1}{2}$	.5	$\frac{53}{64}$	.8437
$\frac{8}{64}$	.1718	$\frac{33}{64}$	.5156	$\frac{27}{32}$	.8593
$\frac{3}{16}$	.1875	$\frac{35}{64}$	.5312	$\frac{55}{64}$	.875
$\frac{9}{64}$	.2031	$\frac{1}{2}$	.5468	$\frac{57}{64}$	.8906
$\frac{10}{64}$	.2187	$\frac{9}{16}$	.5625	$\frac{29}{32}$	.9062
$\frac{11}{64}$	.2343	$\frac{37}{64}$	.5781	$\frac{59}{64}$	.9218
$\frac{1}{4}$	.25	$\frac{19}{32}$	.5937	$\frac{39}{64}$	.9375
$\frac{12}{64}$	.2656	$\frac{39}{64}$	.6093	$\frac{15}{16}$	.9531
$\frac{13}{64}$	.2812	$\frac{5}{8}$	.625	$\frac{61}{64}$	.9687
$\frac{14}{64}$	.2968	$\frac{41}{64}$	.6406	$\frac{31}{32}$	.9843
$\frac{15}{64}$	.3125	$\frac{21}{32}$	.6562	1	1.0
$\frac{1}{2}$	.3281	$\frac{43}{64}$	.6718		
$\frac{16}{32}$	.3437	$\frac{11}{16}$	.6875		

See notes on Assemblages and Tappings, page 55.